



2 0 2 3 C A B I N E T & A R C H I T E C T U R A L H A R D W A R E

OMNIA

MANUFACTURERS OF FINE LOCKSETS & ARCHITECTURAL HARDWARE

Suggested Retail Prices Effective January 3, 2023

# Table of Contents

SECTION	PAGE
Finishes Chart	3
<b>CABINET/APPLIANCE PULLS &amp; KNOBS • SOLID BRASS &amp; GLASS</b>	
Elite	4-5
Ultima III	6-8
Ultima Knobs	9
Ultima II	10-12
Ultima I	13-15
Traditions	16-17
Prodigy	17
<b>CABINET/APPLIANCE PULLS &amp; KNOBS • STAINLESS STEEL</b>	
Cabinet Pulls	18-20
Cabinet Knobs	21
<b>CABINET KNOBS &amp; PULLS • SOLID BRASS</b>	
Legacy	22
Ornate	23
<b>ALL DOOR PULLS/APPLIANCE PULLS</b>	
Stainless Steel	24
Elite	24
Traditions	25
Ultima I	25
Ultima II	26
Ultima III	27
<b>MISC. ARCHITECTURAL HARDWARE</b>	
Flushcups • Solid Brass & Stainless Steel	28-29
Door Stops & Ball Catch • Solid Brass & Stainless Steel	30
Latch & Decorative Hooks • Solid Brass	31
Switchplates • Solid Brass	32-34
<b>OMNIA TERMS &amp; CONDITIONS</b>	<b>35</b>

The story of OMNIA began over fifty-five years ago when our company's founder, Alberto R. Comini came to this country with a vision to introduce to the U.S. market beautifully designed and crafted Italian architectural hardware. To this day, OMNIA has steadfast ties to Italy and while now helmed by the next generation of Comini family members, we continue to stay true to our founding principle of forging our own path.

It is all the people behind the products that make up the OMNIA family including our fiercely loyal employees and our customers with whom we have fostered long-standing relationships. As our business grows, so does our family tree and new opportunities are greeted with Italian hospitality and warmth.

Over the course of our history, OMNIA has built a legacy upon developing products innovative in both design and technological advancement. Our focus is always on what lies ahead and we constantly challenge ourselves to stay in the forefront of our industry. This latest presentation showcases our current product offerings shown with suggested retail prices.

Our products are meticulously fabricated from the finest brass materials or premium-grade stainless steel in order to meet the exceptional standards of the finished project of your dreams. Choose the hardware that is expressly YOU and come to know the look and feel of OMNIA.



# OMNIA Finishes

*Always check each item number to make sure a finish is available for a particular design.*

	Code	Description		Code	Description
	US3	POLISHED BRASS, LACQUERED		US14	POLISHED NICKEL PLATED, LACQUERED
	US3A	POLISHED BRASS, UNLACQUERED		US15	SATIN NICKEL PLATED, LACQUERED
	US4	SATIN BRASS, LACQUERED		US26	POLISHED CHROME PLATED
	US5	ANTIQUÉ BRASS, LACQUERED		US32D	SATIN STAINLESS STEEL
	US10B	BLACK, OIL-RUBBED, LACQUERED			

## Additional Finishes

*(Only available on certain items)*

	US15A	PEWTER, LACQUERED		US26D	SATIN CHROME PLATED		SB	SHADED BRONZE, LACQUERED		VB	VINTAGE BRASS
	VC	VINTAGE COPPER		VI	VINTAGE IRON		PBL	PVD BLACK		PDB	PVD DARK BRONZE
	PSG	PVD SATIN GOLD		PTT	PVD TITANIUM						

# ELITE



US4

US5

US10B

US14

US15

US26

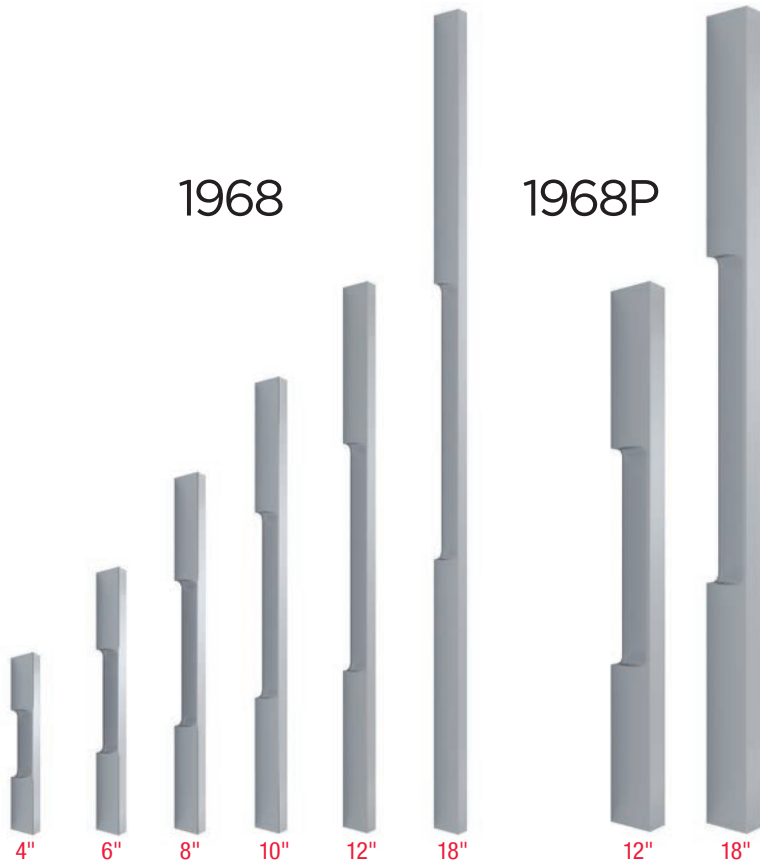

1968

1968P

4"

6"

8"

10"

12"

18"

12"

18"

Item#	Center to Center	Overall Length	Proj.	FINISHES		
				US4 US14 US26	US5 US10B US15	
<b>1968</b> Cabinet Pull 5/16" W	1968/102	4"	4 1/2"	1 1/16"	\$40	\$45
	1968/153	6"	6 1/2"		45	52
	1968/203	8"	8 1/2"		54	60
	1968/254	10"	10 1/2"		57	67
	1968/305	12"	12 1/2"		69	78
1968/457	18"	18 1/2"		80	90	
<b>1968P</b> Appliance Pull 1 9/32" W	1968P/305	12"	12 15/16"	1 3/16"	\$203	\$215
	1968P/305BB*	12"	12 15/16"		203	215
	1968P/457	18"	18 15/16"		261	272
	1968P/457BB*	18"	18 15/16"		261	272

\*In order to achieve back-to-back, order one regular pull and one BB.

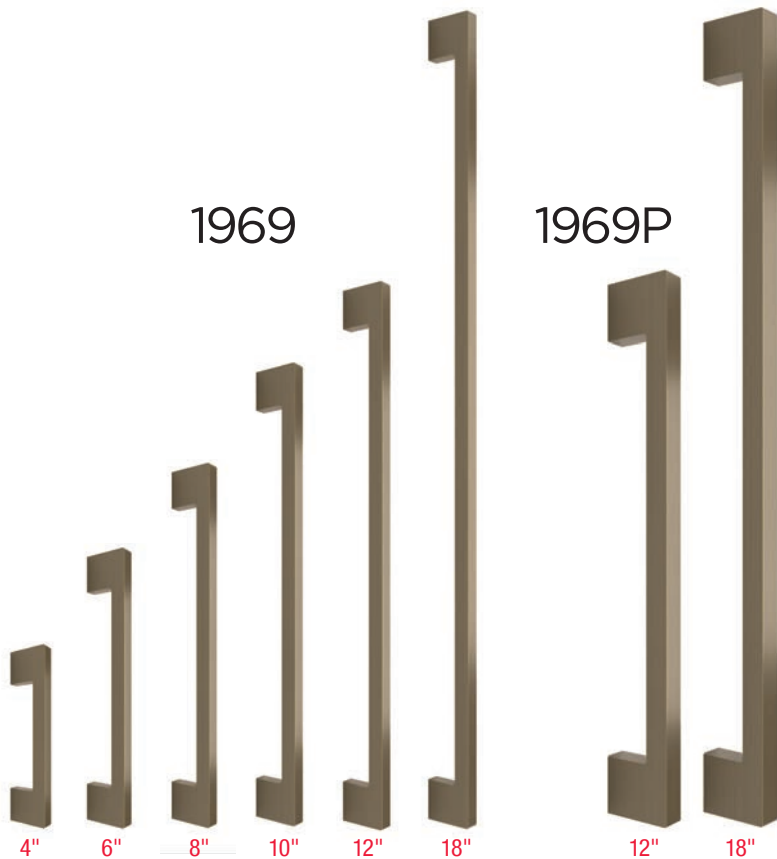

1969

1969P

4"

6"

8"

10"

12"

18"

12"

18"



US4

US5

US10B

US14

US15

US26

Item#	Center to Center	Overall Length	Proj.	FINISHES		
				US4 US14 US26	US5 US10B US15	
<b>1969</b> Cabinet Pull 5/16" W	1969/102	4"	4 15/16"	1 3/16"	\$50	\$54
	1969/153	6"	6 15/16"		60	66
	1969/203	8"	8 15/16"		69	80
	1969/254	10"	10 15/16"		79	87
	1969/305	12"	12 15/16"		90	100
1969/457	18"	18 15/16"		120	128	
<b>1969P</b> Appliance Pull 1 9/32" W	1969P/305	12"	13 1/8"	1 3/4"	\$220	\$229
	1969P/305BB*	12"	13 1/8"		220	229
	1969P/457	18"	19 1/8"		272	278
	1969P/457BB*	18"	19 1/8"		272	278

\*In order to achieve back-to-back, order one regular pull and one BB.

Suggested retail prices effective January 3, 2023.

# ELITE

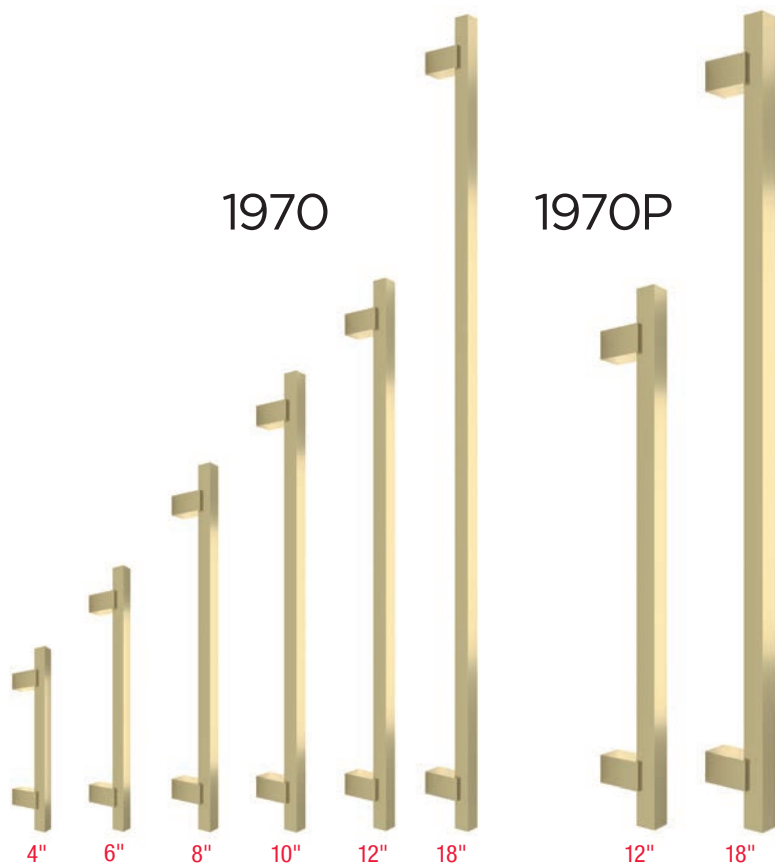

Item#	Center to Center	Overall Length	Proj.	FINISHES		
				US4 US14 US26	US5 US10B US15	US10B US15
<b>1970</b>						
<b>Cabinet Pull</b>						
1970/102	4"	5 <sup>15</sup> / <sub>16</sub> "	1 <sup>1</sup> / <sub>4</sub> "	<b>\$72</b>	<b>\$78</b>	
1970/153	6"	7 <sup>15</sup> / <sub>16</sub> "		<b>76</b>	<b>88</b>	
1970/203	8"	9 <sup>15</sup> / <sub>16</sub> "		<b>80</b>	<b>96</b>	
9 <sup>9</sup> / <sub>16</sub> " W	10"	11 <sup>15</sup> / <sub>16</sub> "		<b>84</b>	<b>101</b>	
1970/305	12"	13 <sup>15</sup> / <sub>16</sub> "		<b>90</b>	<b>110</b>	
1970/457	18"	19 <sup>15</sup> / <sub>16</sub> "		<b>99</b>	<b>114</b>	
<b>1970P</b>						
<b>Appliance Pull</b>						
1970P/305	12"	14 <sup>3</sup> / <sub>4</sub> "	1 <sup>3</sup> / <sub>4</sub> "	<b>\$220</b>	<b>\$229</b>	
1970P/305BB*	12"	14 <sup>3</sup> / <sub>4</sub> "		<b>220</b>	<b>229</b>	
1970P/457	18"	20 <sup>3</sup> / <sub>4</sub> "		<b>272</b>	<b>278</b>	
1 <sup>3</sup> / <sub>16</sub> " W	18"	20 <sup>3</sup> / <sub>4</sub> "		<b>272</b>	<b>278</b>	

\*In order to achieve back-to-back, order one regular pull and one BB.

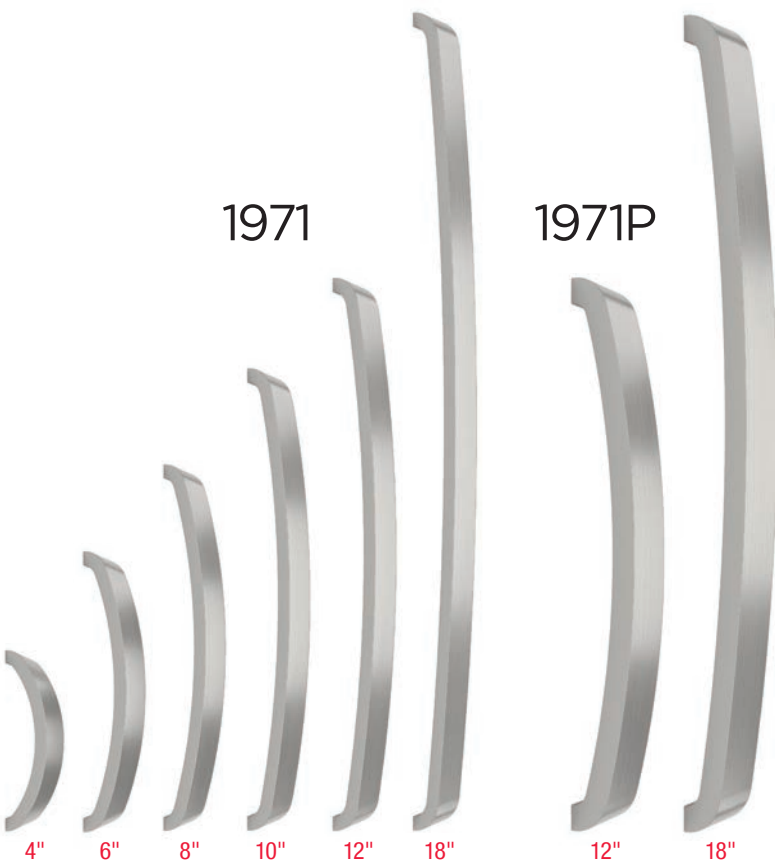

Item#	Center to Center	Overall Length	Proj.	FINISHES		
				US4 US14 US26	US5 US10B US15	US10B US15
<b>1971</b>						
<b>Cabinet Pull</b>						
1971/102	4"	4 <sup>3</sup> / <sub>8</sub> "	1 <sup>3</sup> / <sub>16</sub> "	<b>\$40</b>	<b>\$45</b>	
1971/153	6"	6 <sup>3</sup> / <sub>8</sub> "		<b>45</b>	<b>52</b>	
1971/203	8"	8 <sup>3</sup> / <sub>8</sub> "		<b>54</b>	<b>60</b>	
3 <sup>3</sup> / <sub>4</sub> " W	10"	10 <sup>3</sup> / <sub>8</sub> "		<b>57</b>	<b>67</b>	
1971/305	12"	12 <sup>3</sup> / <sub>8</sub> "		<b>69</b>	<b>78</b>	
1971/457	18"	18 <sup>3</sup> / <sub>8</sub> "		<b>80</b>	<b>91</b>	
<b>1971P</b>						
<b>Appliance Pull</b>						
1971P/305	12"	12 <sup>11</sup> / <sub>16</sub> "	1 <sup>3</sup> / <sub>4</sub> "	<b>\$203</b>	<b>\$215</b>	
1971P/305BB*	12"	12 <sup>11</sup> / <sub>16</sub> "		<b>203</b>	<b>215</b>	
1971P/457	18"	18 <sup>9</sup> / <sub>16</sub> "		<b>261</b>	<b>272</b>	
1 <sup>3</sup> / <sub>16</sub> " W	18"	18 <sup>9</sup> / <sub>16</sub> "		<b>261</b>	<b>272</b>	

\*In order to achieve back-to-back, order one regular pull and one BB.

Suggested retail prices effective January 3, 2023.

# Ultima III

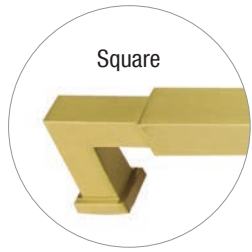

9029

9029P



Item#	Center to Center	Overall Length	Proj.	FINISHES					
				US3A	US4	US5	US10B	US14	US15
<b>9029</b> Cabinet Pull 7/16" W	9029/102	4"	4 7/16"	1 3/16"	\$28				
	9029/153	6"	6 7/16"		\$38				
	9029/203	8"	8 7/16"		\$50				
	9029/254	10"	10 7/16"		\$60				
	9029/305	12"	12 7/16"		\$72				
	9029/457	18"	18 7/16"		\$103				
<b>9029P</b> Appliance Pull 3/4" W	9029P/305	12"	12 3/4"	2 3/16"	\$234				
	9029P/305B*	12"	12 3/4"		\$234				
	9029P/457	18"	18 3/4"		\$345				
	9029P/457B*	18"	18 3/4"		\$345				

\*In order to achieve back-to-back, order one regular pull and one B.

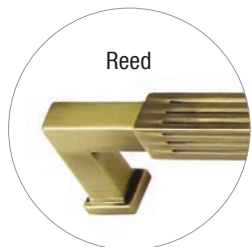

9031

9031P



Item#	Center to Center	Overall Length	Proj.	FINISHES					
				US3A	US4	US5	US10B	US14	US15
<b>9031</b> Cabinet Pull 7/16" W	9031/102	4"	4 7/16"	1 3/16"	\$34				
	9031/153	6"	6 7/16"		\$46				
	9031/203	8"	8 7/16"		\$56				
	9031/254	10"	10 7/16"		\$67				
	9031/305	12"	12 7/16"		\$78				
	9031/457	18"	18 7/16"		\$111				
<b>9031P</b> Appliance Pull 3/4" W	9031P/305	12"	12 3/4"	2 3/16"	\$249				
	9031P/305B*	12"	12 3/4"		\$249				
	9031P/457	18"	18 3/4"		\$370				
	9031P/457B*	18"	18 3/4"		\$370				

\*In order to achieve back-to-back, order one regular pull and one B.

Suggested retail prices effective January 3, 2023.

# Ultima III

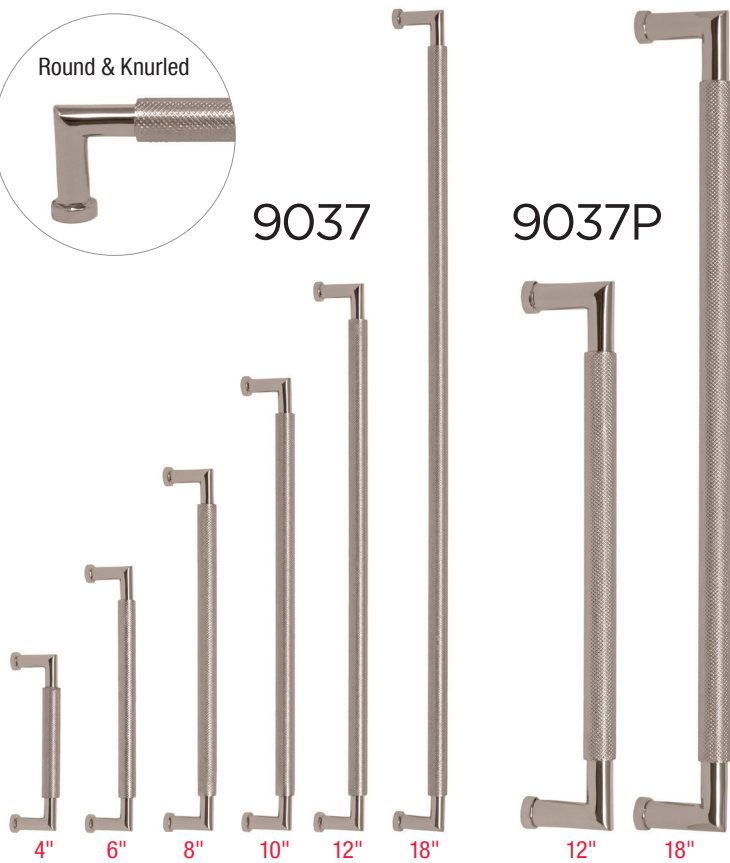

Item#	Center to Center	Overall Length	Proj.	FINISHES				
				US3A	US4	US5	US10B US14 US15 US26	
<b>9037</b> Cabinet Pull	9037/102	4"	4 <sup>7</sup> / <sub>16</sub> "	1 <sup>1</sup> / <sub>8</sub> "				<b>\$28</b>
	9037/153	6"	6 <sup>7</sup> / <sub>16</sub> "					<b>38</b>
	9037/203	8"	8 <sup>7</sup> / <sub>16</sub> "					<b>50</b>
	7 <sup>1</sup> / <sub>16</sub> " max. dia.	9037/254	10"	10 <sup>7</sup> / <sub>16</sub> "				<b>60</b>
	9037/305	12"	12 <sup>7</sup> / <sub>16</sub> "					<b>72</b>
9037/457	18"	18 <sup>7</sup> / <sub>16</sub> "					<b>103</b>	
<b>9037P</b> Appliance Pull	9037P/305	12"	12 <sup>3</sup> / <sub>4</sub> "	2 <sup>1</sup> / <sub>8</sub> "				<b>\$234</b>
	9037P/305B*	12"	12 <sup>3</sup> / <sub>4</sub> "					<b>234</b>
	9037P/457	18"	18 <sup>3</sup> / <sub>4</sub> "					<b>345</b>
	3 <sup>3</sup> / <sub>4</sub> " max. dia.	9037P/457B*	18"	18 <sup>3</sup> / <sub>4</sub> "				<b>345</b>

\*In order to achieve back-to-back, order one regular pull and one B.

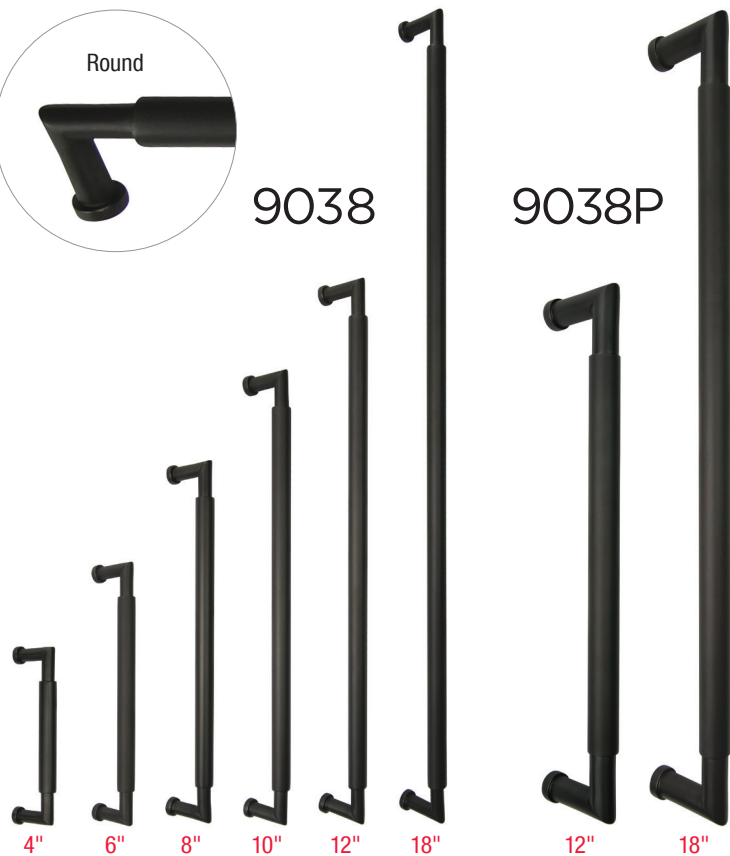

Item#	Center to Center	Overall Length	Proj.	FINISHES				
				US3A	US4	US5	US10B US14 US15 US26	
<b>9038</b> Cabinet Pull	9038/102	4"	4 <sup>7</sup> / <sub>16</sub> "	1 <sup>1</sup> / <sub>8</sub> "				<b>\$28</b>
	9038/153	6"	6 <sup>7</sup> / <sub>16</sub> "					<b>38</b>
	9038/203	8"	8 <sup>7</sup> / <sub>16</sub> "					<b>50</b>
	7 <sup>1</sup> / <sub>16</sub> " max. dia.	9038/254	10"	10 <sup>7</sup> / <sub>16</sub> "				<b>60</b>
	9038/305	12"	12 <sup>7</sup> / <sub>16</sub> "					<b>72</b>
9038/457	18"	18 <sup>7</sup> / <sub>16</sub> "					<b>103</b>	
<b>9038P</b> Appliance Pull	9038P/305	12"	12 <sup>3</sup> / <sub>4</sub> "	2 <sup>1</sup> / <sub>8</sub> "				<b>\$234</b>
	9038P/305B*	12"	12 <sup>3</sup> / <sub>4</sub> "					<b>234</b>
	9038P/457	18"	18 <sup>3</sup> / <sub>4</sub> "					<b>345</b>
	3 <sup>3</sup> / <sub>4</sub> " max. dia.	9038P/457B*	18"	18 <sup>3</sup> / <sub>4</sub> "				<b>345</b>

\*In order to achieve back-to-back, order one regular pull and one B.

Suggested retail prices effective January 3, 2023.

# Ultima III



9039



9039P



	Item#	Center to Center	Overall Length	Proj.	FINISHES					
					US3A	US4	US5	US10B	US14	US15
<b>9039</b> Cabinet Pull 1/2" w	9039/102	4"	4 7/16"	1 1/8"	\$28					
	9039/153	6"	6 7/16"		38					
	9039/203	8"	8 7/16"		50					
	9039/254	10"	10 7/16"		60					
	9039/305	12"	12 7/16"		72					
	9039/457	18"	18 7/16"		103					
<b>9039P</b> Appliance Pull 1 3/16" w	9039P/305	12"	12 3/4"	2 1/8"	\$234					
	9039P/305B*	12"	12 3/4"		234					
	9039P/457	18"	18 3/4"		345					
	9039P/457B*	18"	18 3/4"		345					

\*In order to achieve back-to-back, order one regular pull and one B.

Suggested retail prices effective January 3, 2023.



# Ultima Knobs

9004

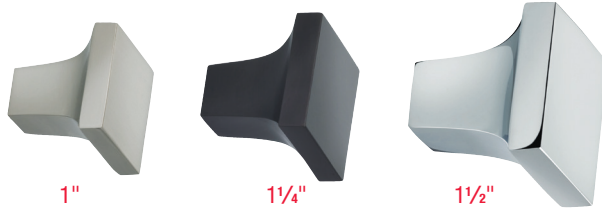

1"

1 1/4"

1 1/2"

Item#	Width	Proj.	FINISHES							
			US3A US10B US15	US4 US14 US26	US5					
<b>9004 Knob</b>	9004/25	1" sq.	1"							
	9004/32	1 1/4" sq.	1 1/4"							\$16
	9004/40	1 1/2" sq.	1 1/2"							\$23

9035



1"

1 1/4"

1 1/2"

Item#	Dia.	Proj.	FINISHES							
			US3A US10B US15	US4 US14 US26	US5					
<b>9035 Knob</b>	9035/25	1"	1"							
	9035/32	1 1/4"	1 1/4"							\$16
	9035/38	1 1/2"	1 1/2"							\$23

9036



1"

1 1/4"

1 1/2"

Item#	Dia.	Proj.	FINISHES							
			US3A US10B US15	US4 US14 US26	US5					
<b>9036 Knob</b>	9036/25	1"	1 5/16"							
	9036/32	1 1/4"	1 5/16"							\$16
	9036/38	1 1/2"	1 1/2"							\$23

9164



1"

1 1/4"

1 1/2"

Item#	Width of Knob	Width of Rose	Proj.	FINISHES						
				US3A US10B US15	US4 US14 US26	US5				
<b>9164 Knob</b>	9164/25	1"	7/8"	1"						
	9164/32	1 1/4"	1"	1 1/4"						\$16
	9164/38	1 1/2"	1 1/4"	1 3/8"						\$23

9165



1"

1 3/16"

1 3/8"

Rose is optional upon installation.

Item#	Dia. of Knob	Dia. of Rose	Proj.	FINISHES						
				US3 US10B US26	US3A US14 US26D	US4 US14 US26	US5			
<b>9165 Knob</b>	9165/25	1"	7/8"	1 5/8"						
	9165/30	1 3/16"	1"	1 3/4"						\$16
	9165/35	1 3/8"	1"	1 7/8"						\$23

9151



1"

1 3/16"

1 3/8"

Rose is optional upon installation.

Item#	Dia. of Knob	Dia. of Rose	Proj.	FINISHES						
				US3 US10B US15	US3A US14 US26	US4 US14 US26	US5			
<b>9151 Knob</b>	9151/25	1"	7/8"	1"						
	9151/30	1 3/16"	1 1/8"	1 1/4"						\$12
	9151/35	1 3/8"	1 1/8"	1 1/2"						\$17

9153

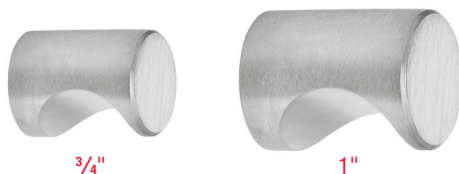

3/4"

1"

Item#	Dia.	Proj.	FINISHES							
			US3 US10B US26	US3A US14 US26	US4 US14 US26	US5				
<b>9153 Knob</b>	9153/18	3/4"	1 5/16"							\$12
	9153/25	1"	1 1/4"							\$17

Suggested retail prices effective January 3, 2023.

# Ultima II

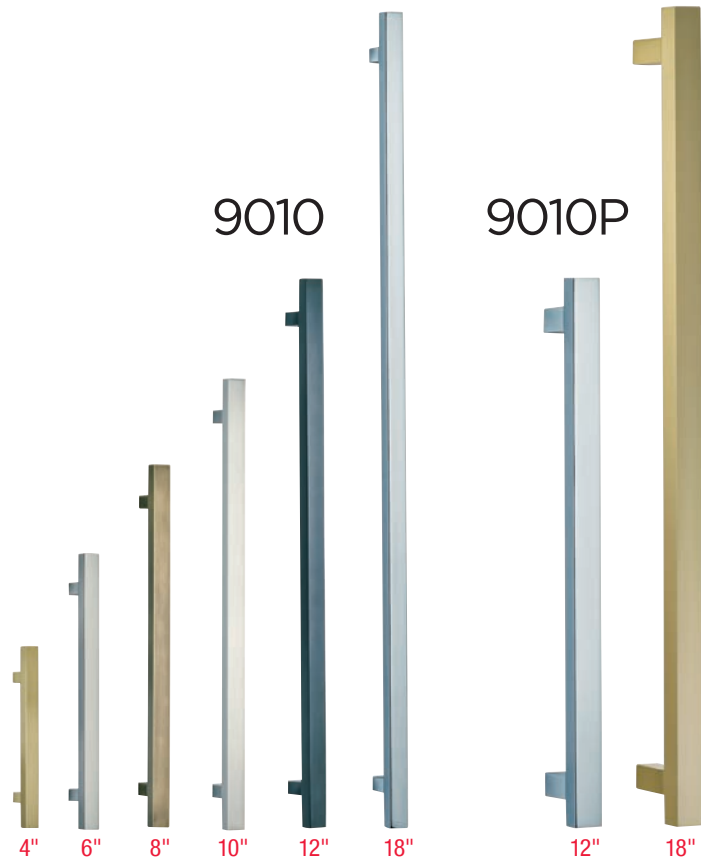

	Item#	Center to Center	Overall Length	Proj.	FINISHES	
					US4 US14 US15 US26	US5 US10B
<b>9010</b> Cabinet Pull 1/2" w	9010/102	4"	6"	1 3/8"	<b>\$34</b>	<b>\$40</b>
	9010/153	6"	8"		<b>44</b>	<b>51</b>
	9010/203	8"	10"		<b>54</b>	<b>62</b>
	9010/254	10"	12"		<b>63</b>	<b>73</b>
	9010/305	12"	14"		<b>73</b>	<b>84</b>
9010/457	18"	20"		<b>102</b>	<b>118</b>	
<b>9010P</b> Appliance Pull 3/4" w	9010P/305	12"	14"	2 5/16"	<b>\$177</b>	<b>203</b>
	9010P/305B*	12"	14"		<b>177</b>	<b>203</b>
	9010P/457	18"	20"		<b>248</b>	<b>285</b>
	9010P/457B*	18"	20"		<b>248</b>	<b>285</b>

\*In order to achieve back-to-back, order one regular pull and one B.



	Item#	Center to Center	Overall Length	Proj.	FINISHES	
					US4 US14 US15 US26	US5 US10B
<b>9023</b> Cabinet Pull 5/16" w	9023/102	4"	4 1/2"	1 3/8"	<b>\$18</b>	<b>\$20</b>
	9023/153	6"	6 1/2"		<b>24</b>	<b>28</b>
	9023/203	8"	8 1/2"		<b>30</b>	<b>34</b>
	9023/254	10"	10 1/2"		<b>38</b>	<b>42</b>
	9023/305	12"	12 1/2"		<b>42</b>	<b>50</b>
9023/457	18"	18 1/2"		<b>62</b>	<b>72</b>	
<b>9023P</b> Appliance Pull 5/8" w	9023P/305	12"	12 3/4"	2 3/16"	<b>\$172</b>	<b>\$197</b>
	9023P/305B*	12"	12 3/4"		<b>172</b>	<b>197</b>
	9023P/457	18"	18 3/4"		<b>238</b>	<b>273</b>
	9023P/457B*	18"	18 3/4"		<b>238</b>	<b>273</b>

\*In order to achieve back-to-back, order one regular pull and one B.

Suggested retail prices effective January 3, 2023.

# Ultima II

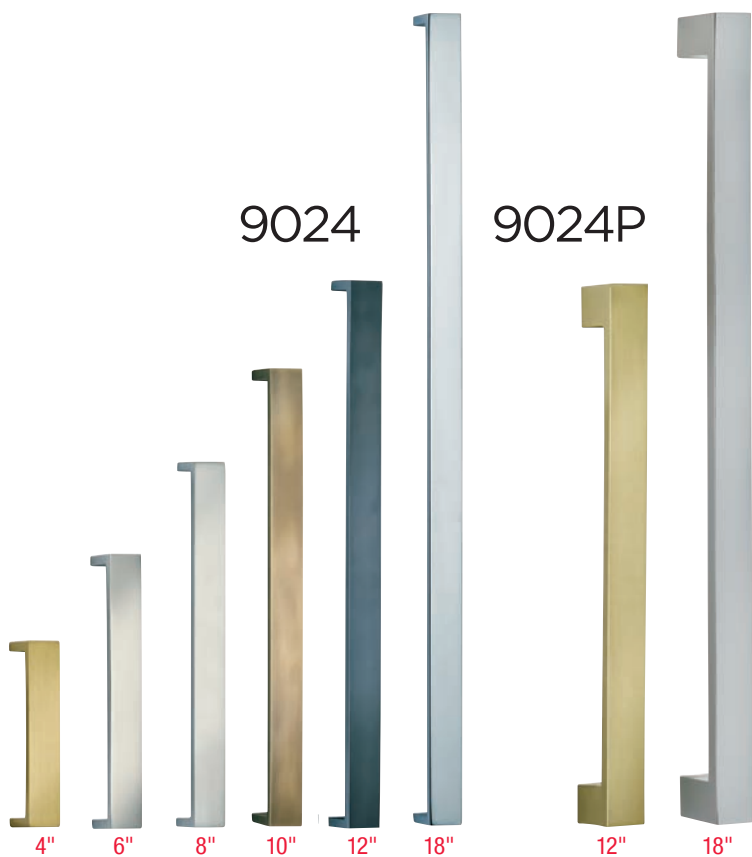

Item#	Center to Center	Overall Length	Proj.	FINISHES		
				US4 US14 US15 US26	US5 US10B	
<b>9024</b> Cabinet Pull 3/4" w	9024/102	4"	4 1/4"	1 3/16"	<b>\$24</b>	<b>\$28</b>
	9024/153	6"	6 1/4"		<b>31</b>	<b>35</b>
	9024/203	8"	8 1/4"		<b>39</b>	<b>44</b>
	9024/254	10"	10 1/4"		<b>46</b>	<b>53</b>
	9024/305	12"	12 1/4"		<b>53</b>	<b>61</b>
9024/457	18"	18 1/4"		<b>75</b>	<b>87</b>	
<b>9024P</b> Appliance Pull 1" w	9024P/305	12"	13"	2"	<b>\$154</b>	<b>\$177</b>
	9024P/305B*	12"	13"		<b>154</b>	<b>177</b>
	9024P/457	18"	19"		<b>206</b>	<b>237</b>
	9024P/457B*	18"	19"		<b>206</b>	<b>237</b>

\*In order to achieve back-to-back, order one regular pull and one B.

Bases are larger than cabinet pull bases to accommodate appliance mounting screws.

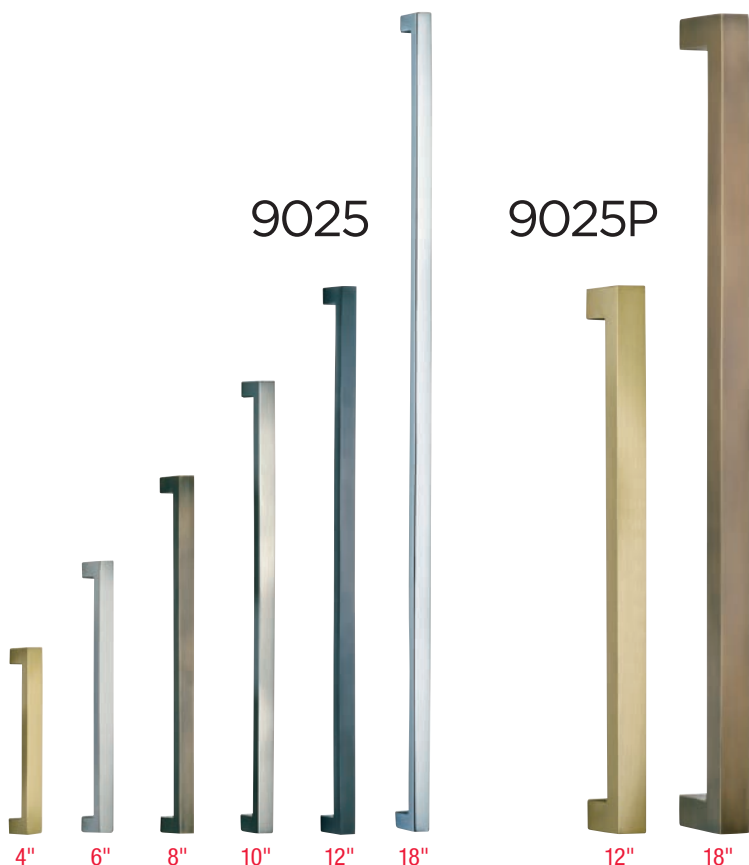

Item#	Center to Center	Overall Length	Proj.	FINISHES		
				US4 US14 US15 US26	US5 US10B	
<b>9025</b> Cabinet Pull 3/8" w	9025/102	4"	4 7/16"	1 3/16"	<b>\$20</b>	<b>\$23</b>
	9025/153	6"	6 7/16"		<b>28</b>	<b>31</b>
	9025/203	8"	8 7/16"		<b>33</b>	<b>38</b>
	9025/254	10"	10 7/16"		<b>40</b>	<b>46</b>
	9025/305	12"	12 7/16"		<b>47</b>	<b>54</b>
9025/457	18"	18 7/16"		<b>66</b>	<b>75</b>	
<b>9025P</b> Appliance Pull 3/4" w	9025P/305	12"	12 3/4"	2"	<b>\$176</b>	<b>\$202</b>
	9025P/305B*	12"	12 3/4"		<b>176</b>	<b>202</b>
	9025P/457	18"	18 3/4"		<b>246</b>	<b>283</b>
	9025P/457B*	18"	18 3/4"		<b>246</b>	<b>283</b>

\*In order to achieve back-to-back, order one regular pull and one B.

Suggested retail prices effective January 3, 2023.

# Ultima II



9027

9027P

Item#	Center to Center	Overall Length	Proj.	FINISHES		
				US4 US14 US15 US26	US5 US10B	
<b>9027</b> Cabinet Pull 3/8" w	9027/102	4"	4 7/16"	1 3/16"	<b>\$15</b>	<b>\$17</b>
	9027/153	6"	6 7/16"		<b>19</b>	<b>23</b>
	9027/203	8"	8 7/16"		<b>24</b>	<b>28</b>
	9027/254	10"	10 7/16"		<b>30</b>	<b>34</b>
	9027/305	12"	12 7/16"		<b>34</b>	<b>40</b>
9027/457	18"	18 7/16"		<b>49</b>	<b>55</b>	
<b>9027P</b> Appliance Pull 3/4" w	9027P/305	12"	12 3/4"	2"	<b>\$139</b>	<b>\$160</b>
	9027P/305B*	12"	12 3/4"		<b>139</b>	<b>160</b>
	9027P/457	18"	18 3/4"		<b>194</b>	<b>224</b>
	9027P/457B*	18"	18 3/4"		<b>194</b>	<b>224</b>

\*In order to achieve back-to-back, order one regular pull and one B.



9028

9028P



Item#	Center to Center	Overall Length	Proj.	FINISHES		
				US4 US14 US15 US26	US5 US10B	
<b>9028</b> Cabinet Pull 7/16" w	9028/102	4"	4 1/2"	1 3/16"	<b>\$17</b>	<b>\$19</b>
	9028/153	6"	6 1/2"		<b>20</b>	<b>24</b>
	9028/203	8"	8 1/2"		<b>26</b>	<b>29</b>
	9028/254	10"	10 1/2"		<b>30</b>	<b>33</b>
	9028/305	12"	12 1/2"		<b>33</b>	<b>39</b>
9028/457	18"	18 1/2"		<b>49</b>	<b>55</b>	
<b>9028P</b> Appliance Pull 1" w	9028P/305	12"	13"	2"	<b>\$146</b>	<b>\$168</b>
	9028P/305B*	12"	13"		<b>146</b>	<b>168</b>
	9028P/457	18"	19"		<b>194</b>	<b>224</b>
	9028P/457B*	18"	19"		<b>194</b>	<b>224</b>

\*In order to achieve back-to-back, order one regular pull and one B.

Suggested retail prices effective January 3, 2023.

# Ultima I

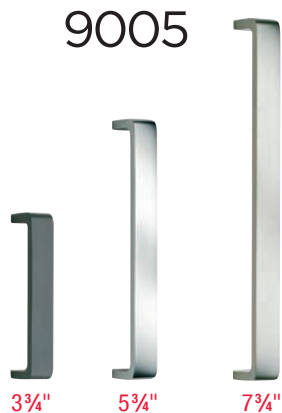

Item#	Center to Center	Overall Length	Proj.	FINISHES		
				US10B US15 US26	NON-STOCK*	
				US10B	US3	US3A
				US15	US4	US5
				US26	US14	
<b>9005</b> Cabinet Pull  5/8" W	9005/96	3 3/4"	4"	1 1/8"	\$16	\$25
	9005/146	5 3/4"	6"		21	30
	9005/197	7 3/4"	8"		30	40

Use 9006P below as a coordinating Appliance Pull.

\*Non-stock finishes require a 12-week lead time and a minimum order of \$500.00 list.



Item#	Center to Center	Overall Length	Proj.	FINISHES		
				US10B US15 US26	NON-STOCK*	
				US10B	US3	US3A
				US15	US4	US5
				US26	US14	
<b>9006</b> Cabinet Pull  15/16" W	9006/96	3 3/4"	4"	1 1/8"	\$24	\$30
	9006/146	5 3/4"	6"		33	42
	9006/197	7 3/4"	8"		44	55
<b>9006P</b> Appliance Pull  1" W	9006P/440	17 5/16"	17 15/16"	2"	\$227	\$284
	9006P/440B**	17 5/16"	17 15/16"		227	284

\*Non-stock finishes require a 12-week lead time and a minimum order of \$500.00 list.

\*\*In order to achieve back-to-back, order one regular pull and one B.

Suggested retail prices effective January 3, 2023.

# Ultima I

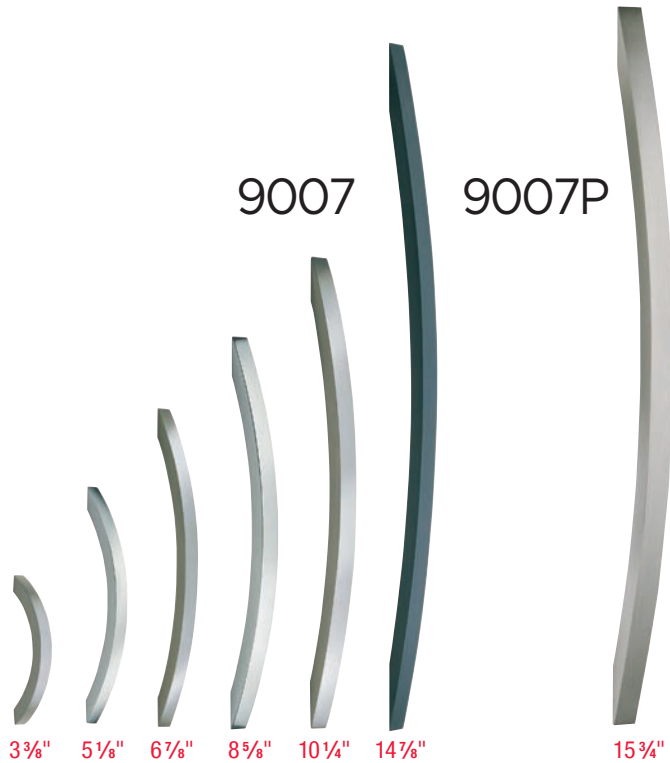

	Item#	Center to Center	Overall Length	Proj.	FINISHES			NON-STOCK*		
					US10B	US15	US26	US3	US3A	US4
<b>9007</b> Cabinet Pull 3/8" W	9007/86	3 3/8"	4"	1 3/16"	<b>\$15</b>			<b>\$20</b>		
	9007/130	5 1/8"	6"		<b>19</b>			<b>29</b>		
	9007/175	6 7/8"	8"		<b>24</b>			<b>33</b>		
1/2" W	9007/220	8 5/8"	10"	1 5/16"	<b>\$50</b>			<b>\$65</b>		
	9007/260	10 1/4"	12"		<b>58</b>			<b>77</b>		
	9007/377	14 7/8"	18"	1 3/8"	<b>87</b>			<b>109</b>		
<b>9007P</b> Appliance Pull 5/8" W	9007P/400**	15 3/4"	17 15/16"	2"	<b>\$170</b>			<b>\$213</b>		

\*Non-stock finishes require a 12-week lead time and a minimum order of \$500.00 list.

\*\*Not available back-to-back.

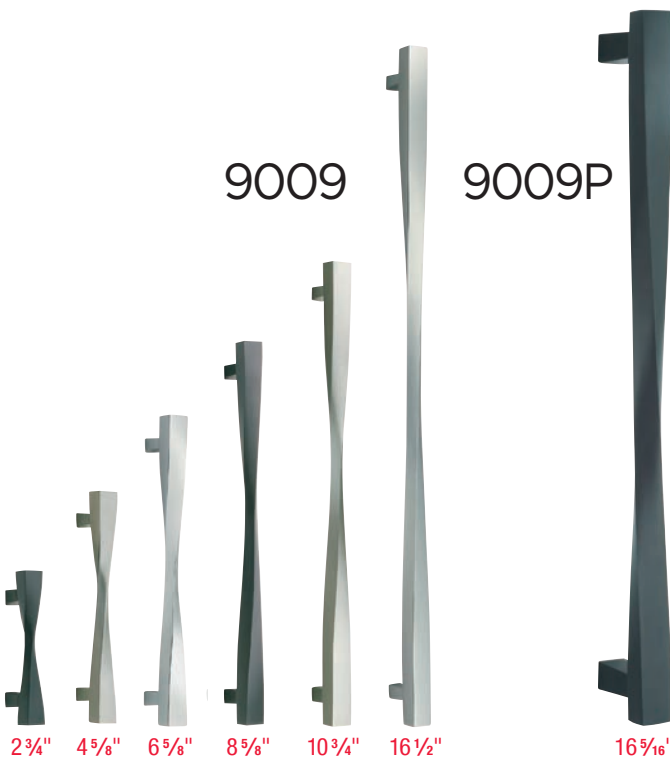

	Item#	Center to Center	Overall Length	Proj.	FINISHES			NON-STOCK*		
					US10B	US15	US26	US3	US3A	US4
<b>9009</b> Cabinet Pull 9/16" W	9009/70	2 3/4"	4"	1 3/8"	<b>\$21</b>			<b>\$28</b>		
	9009/118	4 5/8"	6"		<b>31</b>			<b>41</b>		
	9009/170	6 5/8"	8"		<b>42</b>			<b>55</b>		
	9009/220	8 5/8"	10"		<b>49</b>			<b>63</b>		
	9009/273	10 3/4"	12 1/4"	1 1/2"	<b>69</b>			<b>87</b>		
	9009/420	16 1/2"	18"		<b>101</b>			<b>127</b>		
<b>9009P</b> Appliance Pull 7/8" W at widest point	9009P/415	16 5/16"	18"	2 5/8"	<b>\$297</b>			<b>\$372</b>		
	9009P/415B**	16 5/16"	18"		<b>297</b>			<b>372</b>		

\*Non-stock finishes require a 12-week lead time and a minimum order of \$500.00 list.

\*\*In order to achieve back-to-back, order one regular pull and one B.

Suggested retail prices effective January 3, 2023.

# Ultima I



	Item#	Center to Center	Overall Length	Proj.	FINISHES			NON-STOCK*		
					US10B	US15	US26	US3	US3A	US4
<b>9013</b> Cabinet Pull 3/8" W	9013/150	6"	8"	1 1/8"	<b>\$35</b>			<b>\$46</b>		
	9013/238	9 3/8"	11"		<b>42</b>			<b>55</b>		
	9013/311	12 1/4"	14"		<b>49</b>			<b>64</b>		
<b>9013P</b> Appliance Pull 3/4" W at widest point	9013P/415	16 5/16"	17 15/16"	1 7/8"	<b>\$183</b>			<b>\$229</b>		
	9013P/415B**	16 5/16"	17 15/16"		<b>183</b>			<b>229</b>		

*\*Non-stock finishes require a 12-week lead time and a minimum order of \$500.00 list.*

*\*\*In order to achieve back-to-back, order one regular pull and one B.*

Suggested retail prices effective January 3, 2023.

# TRADITIONS



9030



3 1/2"



5"



7"



12"



18"

Item#	Center to Center	Overall Length	Max. Dia.	FINISHES		
				US3 US14 US15 US26	US5 US10B	
<b>9030</b> Cabinet Pull	9030/89	3 1/2"	4"	15/32"	<b>\$16</b>	<b>\$19</b>
	9030/128	5"	5 1/2"	17/32"	<b>21</b>	<b>26</b>
	9030/178	7"	7 5/8"	5/8"	<b>38</b>	<b>45</b>
<b>9030</b> Appliance Pull	9030/305	12"	12 3/4"	7/8"	<b>\$92</b>	<b>\$108</b>
	9030/458	18"	18 7/8"	1"	<b>197</b>	<b>227</b>



9040



3 1/2"



5"



7"



12"



18"

Item#	Center to Center	Overall Length	Max. Dia.	FINISHES		
				US3 US14 US15 US26	US5 US10B	
<b>9040</b> Cabinet Pull	9040/89	3 1/2"	4"	9/16"	<b>\$16</b>	<b>\$19</b>
	9040/128	5"	5 5/8"	5/8"	<b>21</b>	<b>26</b>
	9040/178	7"	7 5/8"	11/16"	<b>38</b>	<b>45</b>
<b>9040</b> Appliance Pull	9040/305	12"	12 7/8"	13/16"	<b>\$92</b>	<b>\$108</b>
	9040/458	18"	19"	15/16"	<b>197</b>	<b>227</b>

Suggested retail prices effective January 3, 2023.



# TRADITIONS

9045



1"



1 1/4"



1 1/2"



Item#	Dia.	Proj.	FINISHES		
			US3	US5	US10B
<b>9045 Knob</b>	9045/25	1"	1 1/16"	<b>\$14</b>	
	9045/31	1 1/4"	1 5/16"	<b>21</b>	
	9045/38	1 1/2"	1 1/2"	<b>35</b>	

# Prodigy

9566



Item#	Dia.	Proj.	FINISHES		
			US3	US4	US5
<b>9566 Knob</b>	9566/32	1 5/16"	1 1/16"	<b>\$29</b>	

9936



Item#	Dia.	Proj.	FINISHES		
			US3	US4	US5
<b>9936 Knob</b>	9936/32	1 1/4"	1 1/16"	<b>\$29</b>	

9955



Item#	Dia.	Proj.	FINISHES		
			US3	US4	US5
<b>9955 Knob</b>	9955/32	1 1/4"	1 1/16"	<b>\$29</b>	

9956



Item#	Dia.	Proj.	FINISHES		
			US3	US4	US5
<b>9956 Knob</b>	9956/32	1 1/16"	1 1/16"	<b>\$29</b>	

Suggested retail prices effective January 3, 2023.

# STAINLESS STEEL

## 9457



	Item#	Center to Center	Overall Length	Proj.	FINISH US32D
<b>9457</b>	9457/96	3 3/4"	5 3/8"	1"	<b>\$31</b>
<b>Cabinet</b>	9457/128	5"	6 5/8"		<b>31</b>
<b>Pull</b>	9457/160	6 3/8"	7 7/8"		<b>32</b>
8 mm diameter	9457/192	7 5/8"	9 1/8"		<b>34</b>

## 9458

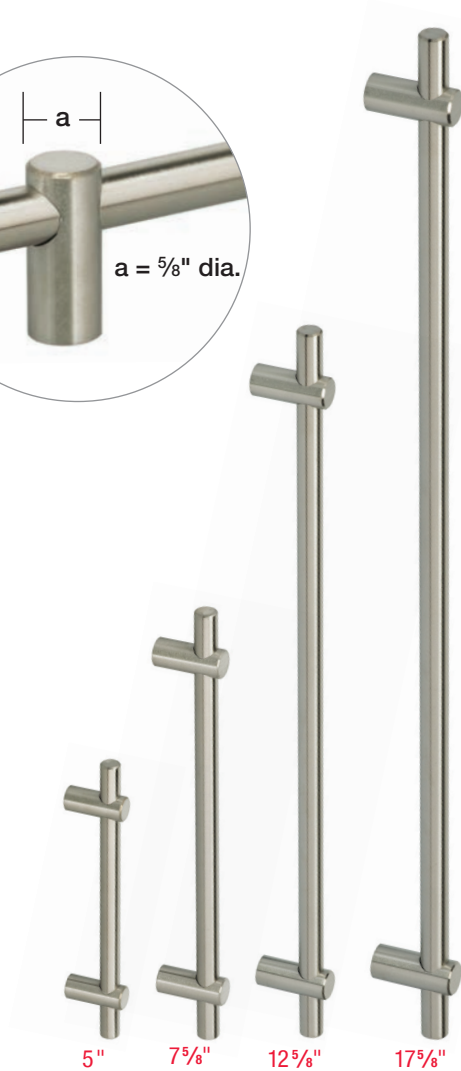
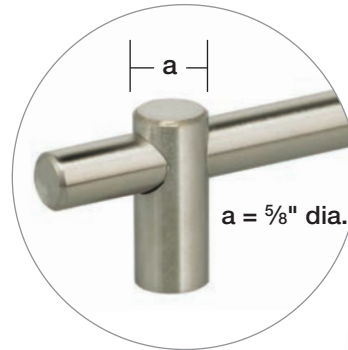

	Item#	Center to Center	Overall Length	Proj.	FINISH US32D
<b>9458</b>	9458/128	5"	7 1/4"	1 1/4"	<b>\$33</b>
<b>Cabinet</b>	9458/192	7 5/8"	9 3/4"		<b>41</b>
<b>Pull</b>	9458/320	12 5/8"	14 15/16"		<b>54</b>
12 mm diameter	9458/448	17 5/8"	20 1/8"		<b>70</b>

Suggested retail prices effective January 3, 2023.

# STAINLESS STEEL

9464



	Item#	Center to Center	Overall Length	Proj.	FINISH US32D
<b>9464</b> Cabinet Pull  10 mm diameter	9464/76	3"	4 <sup>15/16</sup> "	1 <sup>3/16</sup> "	<b>\$14</b>
	9464/96	3 <sup>3/4</sup> "	5 <sup>3/4</sup> "		<b>15</b>
	9464/128	5"	7"		<b>18</b>
	9464/192	7 <sup>5/8</sup> "	9 <sup>1/2</sup> "		<b>23</b>
	9464/320	12 <sup>5/8</sup> "	14 <sup>9/16</sup> "		<b>33</b>
	9464/448	17 <sup>5/8</sup> "	20 <sup>1/2</sup> "		<b>47</b>
	9464/640	25 <sup>3/16</sup> "	28 <sup>3/8</sup> "		<b>85</b>

9465



	Item#	Center to Center	Overall Length	Proj.	FINISH US32D
<b>9465</b> Cabinet Pull  14 mm diameter	9465/96	3 <sup>3/4</sup> "	5 <sup>3/4</sup> "	1 <sup>3/8</sup> "	<b>\$32</b>
	9465/128	5"	7"		<b>37</b>
	9465/192	7 <sup>5/8</sup> "	9 <sup>1/2</sup> "		<b>46</b>
	9465/320	12 <sup>5/8</sup> "	14 <sup>9/16</sup> "		<b>58</b>
	9465/448	17 <sup>5/8</sup> "	20 <sup>1/2</sup> "		<b>70</b>
	9465/640	25 <sup>3/16</sup> "	28 <sup>3/8</sup> "		<b>83</b>
	9465/736	29"	32 <sup>1/4</sup> "		<b>98</b>

Suggested retail prices effective January 3, 2023.

# STAINLESS STEEL

## 9450

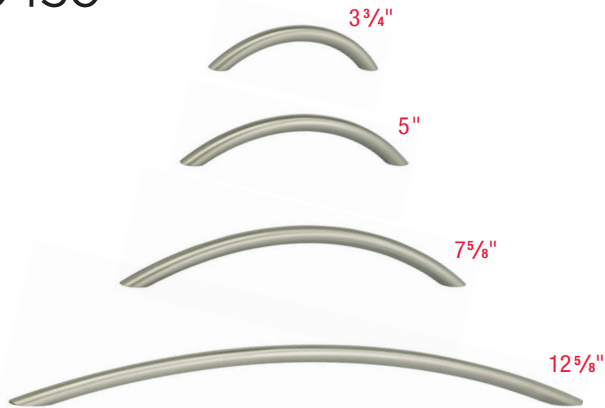

	Item#	Center to Center	Overall Length	Proj.	FINISH US32D
<b>9450</b> Cabinet Pull 10 mm diameter	9450/96	3 <sup>3</sup> / <sub>4</sub> "	4 <sup>5</sup> / <sub>8</sub> "	1 <sup>1</sup> / <sub>8</sub> "	<b>\$14</b>
	9450/128	5"	5 <sup>7</sup> / <sub>8</sub> "	1 <sup>3</sup> / <sub>16</sub> "	<b>15</b>
	9450/192	7 <sup>5</sup> / <sub>8</sub> "	8 <sup>3</sup> / <sub>4</sub> "	1 <sup>3</sup> / <sub>8</sub> "	<b>21</b>
	9450/320	12 <sup>5</sup> / <sub>8</sub> "	14 <sup>9</sup> / <sub>16</sub> "		<b>43</b>

## 9533

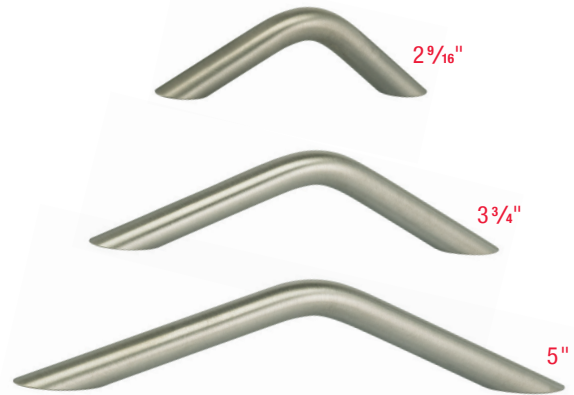

	Item#	Center to Center	Overall Length	Proj.	FINISH US32D
<b>9533</b> Cabinet Pull 10 mm diameter	9533/64	2 <sup>9</sup> / <sub>16</sub> "	3 <sup>5</sup> / <sub>8</sub> "	1 <sup>1</sup> / <sub>8</sub> "	<b>\$13</b>
	9533/96	3 <sup>3</sup> / <sub>4</sub> "	5 <sup>3</sup> / <sub>16</sub> "	1 <sup>3</sup> / <sub>16</sub> "	<b>14</b>
	9533/128	5"	6 <sup>3</sup> / <sub>4</sub> "	1 <sup>1</sup> / <sub>4</sub> "	<b>15</b>

## 9537

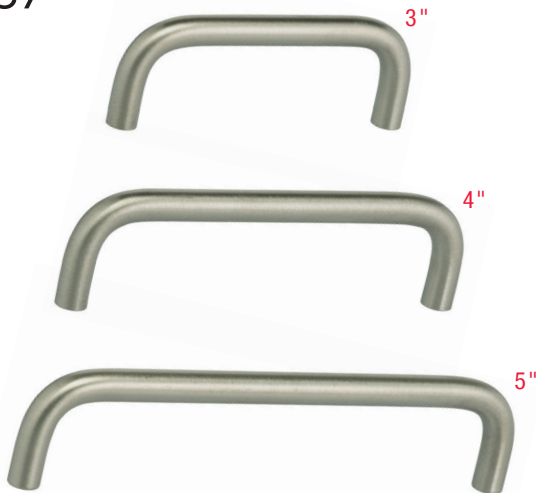

	Item#	Center to Center	Overall Length	Proj.	FINISH US32D
<b>9537</b> Cabinet Pull 8 mm diameter	9537/76	3"	3 <sup>3</sup> / <sub>8</sub> "	1 <sup>3</sup> / <sub>16</sub> "	<b>\$12</b>
	9537/102	4"	4 <sup>3</sup> / <sub>8</sub> "		<b>13</b>
	9537/128	5"	5 <sup>3</sup> / <sub>8</sub> "		<b>14</b>

## 9538



	Item#	Center to Center	Overall Length	Proj.	FINISH US32D
<b>9538</b> Cabinet Pull 10 mm diameter	9538/76	3"	3 <sup>7</sup> / <sub>16</sub> "	1 <sup>3</sup> / <sub>8</sub> "	<b>\$13</b>
	9538/102	4"	4 <sup>7</sup> / <sub>16</sub> "		<b>14</b>
	9538/128	5"	5 <sup>1</sup> / <sub>2</sub> "		<b>15</b>

Suggested retail prices effective January 3, 2023.

# STAINLESS STEEL

## 9100



	Item#	Dia.	Proj.	FINISH US32D
<b>9100</b> Knob	9100/25	1"	7/8"	<b>\$11</b>
	9100/30	1 <sup>3</sup> / <sub>16</sub> "	1 <sup>1</sup> / <sub>8</sub> "	<b>15</b>

## 9153



	Item#	Dia.	Proj.	FINISH US32D
<b>9153</b> Knob	9153/18	3/4"	1"	<b>\$11</b>
	9153/21	1 <sup>3</sup> / <sub>16</sub> "	1 <sup>1</sup> / <sub>8</sub> "	<b>15</b>

## 9180



	Item#	Dia.	Proj.	FINISH US32D
<b>9180</b> Knob	9180/25	1"	1 <sup>1</sup> / <sub>8</sub> "	<b>\$15</b>
	9180/30	1 <sup>3</sup> / <sub>16</sub> "	1 <sup>1</sup> / <sub>4</sub> "	<b>23</b>

## 9181



	Item#	Dia.	Proj.	FINISH US32D
<b>9181</b> Knob	9181/20	3/4"	1"	<b>\$11</b>
	9181/24	1 <sup>5</sup> / <sub>16</sub> "	1 <sup>3</sup> / <sub>16</sub> "	<b>15</b>

Suggested retail prices effective January 3, 2023.

# Legacy

9100  
Knob



Item#	Dia.	Proj.	FINISHES			
			US3 US26	US10B US26D	US14 VB	US15 VC VI
9100/31	1 7/32"	1 1/8"	<b>\$16</b>			

9102  
Knob



Item#	Dia.	Proj.	FINISHES			
			US3 US26	US10B VB	US14 VC	US15 VI
9102/30	1 3/16"	1 1/8"	<b>\$18</b>			

9105  
Knob



Item#	Dia.	Proj.	FINISHES			
			US3 US26	US10B US26D	US14 VB	US15 VC VI
9105/35	1 3/8"	1 1/2"	<b>\$16</b>			

9130  
Knob



Item#	Dia.	Proj.	FINISHES			
			US3	US14	US15	SB
9130/30	1 3/16"	1 1/16"	<b>\$14</b>			

9141  
Knob



Item#	Dia.	Proj.	FINISHES			
			US3 US26	US10B SB	US14 VB	US15 VC VI
9141/30	1 3/16"	1"	<b>\$18</b>			

9158  
Knob



Item#	Dia.	Proj.	FINISHES			
			US3 US15	US10B US26	US14	
9158/30	1 3/16"	1 5/32"	<b>\$18</b>			

9430  
Knob



Item#	Dia.	Proj.	FINISHES			
			US3 US26	US10B SB	US14 VB	US15 VC VI
9430/32	1 1/4"	1 1/4"	<b>\$18</b>			

*Suggested retail prices effective January 3, 2023.*

Suggested retail prices effective January 3, 2023.

# Ornate

## 7105



	Item#	Dia.	Proj.	FINISHES		
				US3	US15A	SB
<b>7105</b> Knob	7105/30	1 3/16"	1"			<b>\$41</b>
	7105/40	1 9/16"	1 3/16"			<b>58</b>

## 7417



	Item#	Dia.	Proj.	FINISHES		
				US3	US15A	SB
<b>7417</b> Knob	7417/28	1 1/8"	1"			<b>\$44</b>
	7417/33	1 3/8"	1 1/8"			<b>42</b>
	7417/42	1 5/8"	1 3/16"			<b>60</b>

## 7420



	Item#	Dia.	Proj.	FINISHES		
				US3	US15A	SB
<b>7420</b> Knob	7420/28	1 1/8"	1 3/16"			<b>\$39</b>
	7420/33	1 5/16"	1"			<b>42</b>
	7420/46	1 13/16"	1 3/16"			<b>58</b>

## 7430



	Item#	Dia.	Proj.	FINISHES		
				US3	US15A	SB
<b>7430</b> Knob	7430/30	1 3/16"	1 1/8"			<b>\$41</b>
	7430/38	1 1/2"	1 1/8"			<b>56</b>
	7430/47	1 7/8"	1 1/8"			<b>70</b>

## 7432



	Item#	Dia.	Proj.	FINISHES		
				US3	US14	US15A SB
<b>7432</b> Pull	7432/76	3"	1 3/8"			<b>\$53</b>
	7432/89	3 1/2"	1 9/16"			<b>61</b>

## 7434



	Item#	Dia.	Proj.	FINISHES		
				US3	US15A	SB
<b>7434</b> Knob	7434/28	1 1/8"	1"			<b>\$38</b>
	7434/35	1 3/8"	1 3/16"			<b>50</b>
	7434/42	1 5/8"	1 1/4"			<b>60</b>

## 7435



	Item#	Dia.	Proj.	FINISHES		
				US3	US15A	SB
<b>7435</b> Knob	7435/25	1"	1 3/16"			<b>\$31</b>
	7435/30	1 3/16"	1"			<b>40</b>
	7435/40	1 9/16"	1 3/16"			<b>50</b>

## 7436



	Item#	Dia.	Proj.	FINISHES		
				US3	US14	US15A SB
<b>7436</b> Knob	7436/25	1"	1 3/16"			<b>\$31</b>
	7436/30	1 3/16"	1"			<b>40</b>
	7436/40	1 9/16"	1 3/16"			<b>55</b>

STAINLESS STEEL

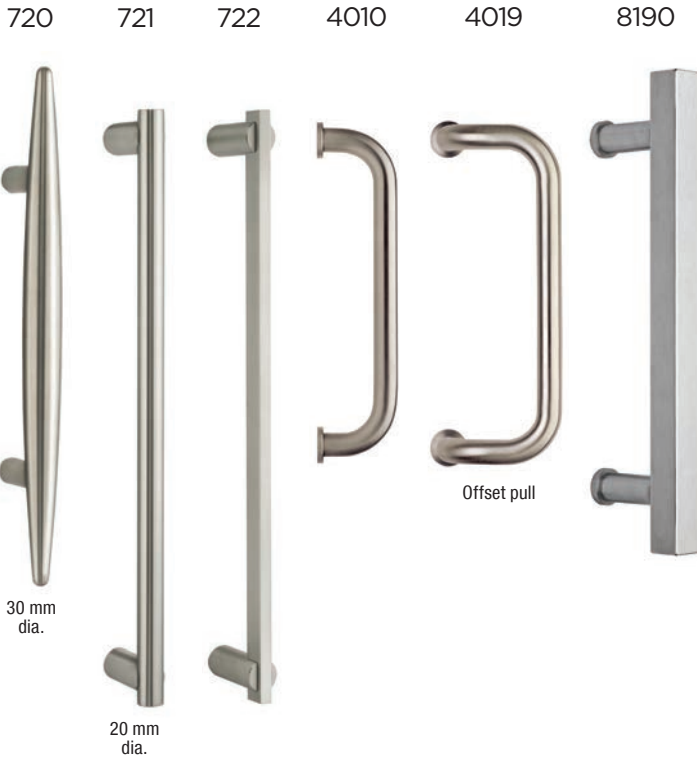

	Item#	Center to Center	Overall Length	Proj.	FINISH US32D
<b>720</b>	720/220	8 <sup>5</sup> / <sub>8</sub> "	15"	2 <sup>3</sup> / <sub>4</sub> "	<b>\$227</b>
<b>721</b>	721/400	15 <sup>3</sup> / <sub>4</sub> "	17 <sup>5</sup> / <sub>16</sub> "	2 <sup>9</sup> / <sub>16</sub> "	<b>\$189</b>
	721/800	31 <sup>1</sup> / <sub>2</sub> "	33"	2 <sup>9</sup> / <sub>16</sub> "	<b>317</b>
<b>722</b>	722/400	15 <sup>3</sup> / <sub>4</sub> "	17 <sup>5</sup> / <sub>16</sub> "	2 <sup>9</sup> / <sub>16</sub> "	<b>\$153</b>
<b>4010</b>	4010/300	8"	9"	2 <sup>5</sup> / <sub>8</sub> "	<b>\$168</b>
	4010/B300	8"	9"	2 <sup>5</sup> / <sub>8</sub> "	<b>356</b>
	4010/400	12"	13 <sup>1</sup> / <sub>4</sub> "	2 <sup>15</sup> / <sub>16</sub> "	<b>222</b>
	4010/B400	12"	13 <sup>1</sup> / <sub>4</sub> "	2 <sup>15</sup> / <sub>16</sub> "	<b>462</b>
	4010/500	16"	17 <sup>1</sup> / <sub>2</sub> "	3 <sup>3</sup> / <sub>8</sub> "	<b>288</b>
4010/B500	16"	17 <sup>1</sup> / <sub>2</sub> "	3 <sup>3</sup> / <sub>8</sub> "	<b>593</b>	
<b>4019</b>	4019/300	8"	9"	2 <sup>5</sup> / <sub>8</sub> "	<b>\$229</b>
	4019/B300	8"	9"	2 <sup>5</sup> / <sub>8</sub> "	<b>478</b>
	4019/400	12"	13 <sup>1</sup> / <sub>4</sub> "	2 <sup>15</sup> / <sub>16</sub> "	<b>283</b>
	4019/B400	12"	13 <sup>1</sup> / <sub>4</sub> "	2 <sup>15</sup> / <sub>16</sub> "	<b>585</b>
	4019/500	16"	17 <sup>1</sup> / <sub>2</sub> "	3 <sup>3</sup> / <sub>8</sub> "	<b>347</b>
4019/B500	16"	17 <sup>1</sup> / <sub>2</sub> "	3 <sup>3</sup> / <sub>8</sub> "	<b>713</b>	
<b>8190</b>	8190/300	11 <sup>13</sup> / <sub>16</sub> "	15 <sup>3</sup> / <sub>4</sub> "	3 <sup>9</sup> / <sub>16</sub> "	<b>\$344</b>
	8190/B300	11 <sup>13</sup> / <sub>16</sub> "	15 <sup>3</sup> / <sub>4</sub> "	3 <sup>9</sup> / <sub>16</sub> "	<b>719</b>
	8190/400	15 <sup>3</sup> / <sub>4</sub> "	23 <sup>5</sup> / <sub>8</sub> "	3 <sup>9</sup> / <sub>16</sub> "	<b>365</b>
	8190/B400	15 <sup>3</sup> / <sub>4</sub> "	23 <sup>5</sup> / <sub>8</sub> "	3 <sup>9</sup> / <sub>16</sub> "	<b>756</b>

For full Stainless Steel line, please see pages 19–23.  
All pulls are available back-to-back.

ELITE



Item#	Center to Center	Overall Length	Proj.	FINISHES	
				US4 US14 US26	US5 US10B US15
<b>1968P</b> 19 <sup>1</sup> / <sub>32</sub> " W	1968P/305	12"	12 <sup>15</sup> / <sub>16</sub> "	1 <sup>3</sup> / <sub>16</sub> "	<b>\$203</b> <b>\$215</b>
	1968P/305BB*	12"	12 <sup>15</sup> / <sub>16</sub> "	1 <sup>3</sup> / <sub>16</sub> "	<b>203</b> <b>215</b>
	1968P/457	18"	18 <sup>15</sup> / <sub>16</sub> "	1 <sup>3</sup> / <sub>16</sub> "	<b>261</b> <b>272</b>
	1968P/457BB*	18"	18 <sup>15</sup> / <sub>16</sub> "	1 <sup>3</sup> / <sub>16</sub> "	<b>261</b> <b>272</b>
<b>1969P</b> 19 <sup>1</sup> / <sub>32</sub> " W	1969P/305	12"	13 <sup>1</sup> / <sub>8</sub> "	1 <sup>3</sup> / <sub>4</sub> "	<b>\$220</b> <b>\$229</b>
	1969P/305BB*	12"	13 <sup>1</sup> / <sub>8</sub> "	1 <sup>3</sup> / <sub>4</sub> "	<b>220</b> <b>229</b>
	1969P/457	18"	19 <sup>1</sup> / <sub>8</sub> "	1 <sup>3</sup> / <sub>4</sub> "	<b>272</b> <b>278</b>
	1969P/457BB*	18"	19 <sup>1</sup> / <sub>8</sub> "	1 <sup>3</sup> / <sub>4</sub> "	<b>272</b> <b>278</b>
<b>1970P</b> 13 <sup>1</sup> / <sub>16</sub> " W	1970P/305	12"	14 <sup>3</sup> / <sub>4</sub> "	1 <sup>3</sup> / <sub>4</sub> "	<b>\$220</b> <b>\$229</b>
	1970P/305BB*	12"	14 <sup>3</sup> / <sub>4</sub> "	1 <sup>3</sup> / <sub>4</sub> "	<b>220</b> <b>229</b>
	1970P/457	18"	20 <sup>3</sup> / <sub>4</sub> "	1 <sup>3</sup> / <sub>4</sub> "	<b>272</b> <b>278</b>
	1970P/457BB*	18"	20 <sup>3</sup> / <sub>4</sub> "	1 <sup>3</sup> / <sub>4</sub> "	<b>272</b> <b>278</b>
<b>1971P</b> 13 <sup>1</sup> / <sub>16</sub> " W	1971P/305	12"	12 <sup>11</sup> / <sub>16</sub> "	1 <sup>3</sup> / <sub>4</sub> "	<b>\$203</b> <b>\$215</b>
	1971P/305BB*	12"	12 <sup>11</sup> / <sub>16</sub> "	1 <sup>3</sup> / <sub>4</sub> "	<b>203</b> <b>215</b>
	1971P/457	18"	18 <sup>9</sup> / <sub>16</sub> "	1 <sup>3</sup> / <sub>4</sub> "	<b>261</b> <b>272</b>
	1971P/457BB*	18"	18 <sup>9</sup> / <sub>16</sub> "	1 <sup>3</sup> / <sub>4</sub> "	<b>261</b> <b>272</b>

\*In order to achieve back-to-back, order one regular pull and one BB.

For full Elite line, please see pages 4–5.

Suggested retail prices effective January 3, 2023.



## TRADITIONS

9030

9040



Item#	Center to Center	Overall Length	Proj.	FINISHES		
				US3 US14 US15 US26	US5 US10B	
<b>9030</b>	9030/305	12"	12 <sup>3</sup> / <sub>4</sub> "	7 <sup>7</sup> / <sub>8</sub> "	<b>\$92</b>	<b>\$108</b>
	9030/458	18"	18 <sup>7</sup> / <sub>8</sub> "	1"	<b>197</b>	<b>227</b>
<b>9040</b>	9040/305	12"	12 <sup>7</sup> / <sub>8</sub> "	13 <sup>1</sup> / <sub>16</sub> "	<b>\$92</b>	<b>\$108</b>
	9040/458	18"	19"	1 <sup>5</sup> / <sub>16</sub> "	<b>197</b>	<b>227</b>

For full Traditions line, please see pages 16–17.

## Ultima I

9006P

9007P

9009P

9013P



Item#	Center to Center	Overall Length	Proj.	FINISHES		NON-STOCK*	
				US15 US10B US26	US3 US3A US4 US5 US14		
<b>9006P</b> 1" w	9006P/440	17 <sup>5</sup> / <sub>16</sub> "	17 <sup>15</sup> / <sub>16</sub> "	2"	<b>\$227</b>	<b>\$284</b>	
	9006P/440B**	17 <sup>5</sup> / <sub>16</sub> "	17 <sup>15</sup> / <sub>16</sub> "	2"	<b>227</b>	<b>284</b>	
<b>9007P</b> 5/8" w	9007P/400†	17 <sup>5</sup> / <sub>16</sub> "	17 <sup>15</sup> / <sub>16</sub> "	2"	<b>\$170</b>	<b>\$213</b>	
<b>9009P</b> 7/8" w at widest point	9009P/415	16 <sup>5</sup> / <sub>16</sub> "	18"	2 <sup>5</sup> / <sub>8</sub> "	<b>\$297</b>	<b>\$372</b>	
	9009P/415B**	16 <sup>5</sup> / <sub>16</sub> "	18"	2 <sup>5</sup> / <sub>8</sub> "	<b>297</b>	<b>372</b>	
<b>9013P</b> 3/4" w (not square)	9013P/415	16 <sup>5</sup> / <sub>16</sub> "	17 <sup>15</sup> / <sub>16</sub> "	1 <sup>7</sup> / <sub>8</sub> "	<b>\$183</b>	<b>\$229</b>	
	9013P/415B**	16 <sup>5</sup> / <sub>16</sub> "	17 <sup>15</sup> / <sub>16</sub> "	1 <sup>7</sup> / <sub>8</sub> "	<b>183</b>	<b>229</b>	

\*Non-stock finishes require a 12-week lead time and a minimum order of \$500.00 list.

\*\*In order to achieve back-to-back, order one regular pull and one B.

† Not available back-to-back.

For full Ultima I line, please see pages 13–15.

Suggested retail prices effective January 3, 2023.

## Ultima II



	Item#	Center to Center	Overall Length	Proj.	FINISHES	
					US4 US14 US15 US26	US5 US10B
<b>9010P</b> 3/4" w	9010P/305	12"	14"	2 5/16"	<b>\$177</b>	<b>\$203</b>
	9010P/305B*	12"	14"	2 5/16"	<b>177</b>	<b>203</b>
	9010P/457	18"	20"	2 5/16"	<b>248</b>	<b>285</b>
	9010P/457B*	18"	20"	2 5/16"	<b>248</b>	<b>285</b>
<b>9023P</b> 5/8" w	9023P/305	12"	12 3/4"	2 3/16"	<b>\$172</b>	<b>\$197</b>
	9023P/305B*	12"	12 3/4"	2 3/16"	<b>172</b>	<b>197</b>
	9023P/457	18"	18 3/4"	2 3/16"	<b>238</b>	<b>273</b>
	9023P/457B*	18"	18 3/4"	2 3/16"	<b>238</b>	<b>273</b>
<b>9024P</b> 1" w	9024P/305	12"	13"	2"	<b>\$154</b>	<b>\$177</b>
	9024P/305B*	12"	13"	2"	<b>154</b>	<b>177</b>
	9024P/457	18"	19"	2"	<b>206</b>	<b>237</b>
	9024P/457B*	18"	19"	2"	<b>206</b>	<b>237</b>
<b>9025P</b> 3/4" w	9025P/305	12"	12 3/4"	2"	<b>\$176</b>	<b>\$202</b>
	9025P/305B*	12"	12 3/4"	2"	<b>176</b>	<b>202</b>
	9025P/457	18"	18 3/4"	2"	<b>246</b>	<b>283</b>
	9025P/457B*	18"	18 3/4"	2"	<b>246</b>	<b>283</b>
<b>9027P</b> 3/4" w	9027P/305	12"	12 3/4"	2"	<b>\$139</b>	<b>\$160</b>
	9027P/305B*	12"	12 3/4"	2"	<b>139</b>	<b>160</b>
	9027P/457	18"	18 3/4"	2"	<b>194</b>	<b>224</b>
	9027P/457B*	18"	18 3/4"	2"	<b>194</b>	<b>224</b>
<b>9028P</b> 3/4" w	9028P/305	12"	13"	2"	<b>\$146</b>	<b>\$168</b>
	9028P/305B*	12"	13"	2"	<b>146</b>	<b>168</b>
	9028P/457	18"	19"	2"	<b>194</b>	<b>224</b>
	9028P/457B*	18"	19"	2"	<b>194</b>	<b>224</b>

\*In order to achieve back-to-back, order one regular pull and one B.

For full Ultima II line, please see pages 10–12.

Suggested retail prices effective January 3, 2023.

## Ultima III



	Item#	Center to Center	Overall Length	Proj.	FINISHES			
					US3A	US4	US5	US10B
					US14	US15	US26	
<b>9029P</b>	9029P/305	12"	12 <sup>3</sup> / <sub>4</sub> "	2 <sup>3</sup> / <sub>16</sub> "	<b>\$234</b>			
<sup>3</sup> / <sub>4</sub> " w	9029P/305B*	12"	12 <sup>3</sup> / <sub>4</sub> "	2 <sup>3</sup> / <sub>16</sub> "	<b>234</b>			
	9029P/457	18"	18 <sup>3</sup> / <sub>4</sub> "	2 <sup>3</sup> / <sub>16</sub> "	<b>345</b>			
	9029P/457B*	18"	18 <sup>3</sup> / <sub>4</sub> "	2 <sup>3</sup> / <sub>16</sub> "	<b>345</b>			
<b>9031P</b>	9031P/305	12"	12 <sup>3</sup> / <sub>4</sub> "	2 <sup>3</sup> / <sub>16</sub> "	<b>\$249</b>			
<sup>3</sup> / <sub>4</sub> " w	9031P/305B*	12"	12 <sup>3</sup> / <sub>4</sub> "	2 <sup>3</sup> / <sub>16</sub> "	<b>249</b>			
	9031P/457	18"	18 <sup>3</sup> / <sub>4</sub> "	2 <sup>3</sup> / <sub>16</sub> "	<b>370</b>			
	9031P/457B*	18"	18 <sup>3</sup> / <sub>4</sub> "	2 <sup>3</sup> / <sub>16</sub> "	<b>370</b>			
<b>9037P</b>	9037P/305	12"	12 <sup>3</sup> / <sub>4</sub> "	2 <sup>1</sup> / <sub>8</sub> "	<b>\$234</b>			
<sup>7</sup> / <sub>16</sub> " max. dia.	9037P/305B*	12"	12 <sup>3</sup> / <sub>4</sub> "	2 <sup>1</sup> / <sub>8</sub> "	<b>234</b>			
	9037P/457	18"	18 <sup>3</sup> / <sub>4</sub> "	2 <sup>1</sup> / <sub>8</sub> "	<b>345</b>			
	9037P/457B*	18"	18 <sup>3</sup> / <sub>4</sub> "	2 <sup>1</sup> / <sub>8</sub> "	<b>345</b>			
<b>9038P</b>	9038P/305	12"	12 <sup>3</sup> / <sub>4</sub> "	2 <sup>1</sup> / <sub>8</sub> "	<b>\$234</b>			
<sup>3</sup> / <sub>4</sub> " max. dia.	9038P/305B*	12"	12 <sup>3</sup> / <sub>4</sub> "	2 <sup>1</sup> / <sub>8</sub> "	<b>234</b>			
	9038P/457	18"	18 <sup>3</sup> / <sub>4</sub> "	2 <sup>1</sup> / <sub>8</sub> "	<b>345</b>			
	9038P/457B*	18"	18 <sup>3</sup> / <sub>4</sub> "	2 <sup>1</sup> / <sub>8</sub> "	<b>345</b>			
<b>9039P</b>	9039P/305	12"	12 <sup>3</sup> / <sub>4</sub> "	2 <sup>1</sup> / <sub>8</sub> "	<b>\$234</b>			
<sup>13</sup> / <sub>16</sub> " w	9039P/305B*	12"	12 <sup>3</sup> / <sub>4</sub> "	2 <sup>1</sup> / <sub>8</sub> "	<b>234</b>			
	9039P/457	18"	18 <sup>3</sup> / <sub>4</sub> "	2 <sup>1</sup> / <sub>8</sub> "	<b>345</b>			
	9039P/457B*	18"	18 <sup>3</sup> / <sub>4</sub> "	2 <sup>1</sup> / <sub>8</sub> "	<b>345</b>			

\*In order to achieve back-to-back, order one regular pull and one B.

For full Ultima III line, please see pages 6–8.

Suggested retail prices effective January 3, 2023.

## Flushcups • Solid Brass & Stainless Steel

652



L x W x D	FINISHES			
	US3	US10B	US26	US15 US26D
4 3/8" x 1 9/16" x 1/2"	\$41	\$46	\$42	

653



L x W x D	FINISHES			
	US3	US10B	US15	US26 US26D
4" x 1 3/4" x 1/2"	\$39	\$52	\$45	\$40

654



L x W x D	FINISHES		
	US3	US14	US26
4" x 1 3/4" x 1/2"	\$41	\$47	\$42
		US15	SB

4297



L x W x D	FINISHES	
	US3	SB
5 3/8" x 1 9/16" x 1/2"	\$91	\$95

7500/65



Dia.	Depth	FINISH
		US32D
2 9/16"	5/8"	\$23

7501/51



Dia.	Depth	FINISH
		US32D
2"	5/8"	\$21

7502/35



Dia.	Depth	FINISH
		US32D
1 3/8"	1/2"	\$28

7503/52



Dia.	D	FINISHES		
		US3	SB	US32D
2 3/16"	3/8"	\$51	\$16	
		US10B	US14	US26

7504/52



Dia.	Depth	FINISHES	
		US3	US32D
2 3/16"	3/8"	\$51	\$16
		US10B	US14
		US15	US26
		SB	

7505/120



L x W x D	FINISH
	US32D
4 3/4" x 1 9/16" x 1/2"	\$21

7506/100



L x W x D	FINISH
	US32D
4" x 2" x 1/2"	\$21

7507



Dia.	Depth	FINISH
		US32D
3 9/16"	1 3/16"	\$28

Suggested retail prices effective January 3, 2023.

## Pocket Door Flushcups • Solid Brass & Stainless Steel

7012



L x W x D  
5" x 2 1/4" x 1/2"  
Proj. 3/32"  
US32D **\$79**

7035



L x W x D  
7" x 2 9/32" x 3/8"  
Proj. 3/32"  
ALL FINISHES **\$103**

7036



L x W x D  
4 1/2" x 2 9/32" x 3/8"  
Proj. 3/32"  
ALL FINISHES **\$79**

7037



L x W x D  
7" x 2 9/32" x 7/16"  
Proj. 1/8"  
ALL FINISHES **\$103**

7039



L x W x D  
7" x 2 9/32" x 7/16"  
Proj. 1/8"  
ALL FINISHES **\$103**



US32D



US3



US3A



US4



US5



US10B



US14



US15



US26



US26D

## Drop Rings & Flushcup • Solid Brass

9580



Item#	Dia.	Depth	FINISHES		
			US3	US4	SB
9580/50	2"	3/8"	<b>\$24</b>	<b>\$28</b>	

9588



Item#	L x W x D	FINISHES		
		US3	US4	SB
9588/60	2 3/8" x 1 7/8" x 3/8"	<b>\$23</b>	<b>\$28</b>	

9595

**D/O - Discontinued when out of stock.**



Item#	Dia.	Depth	FINISHES		
			US3	US4	SB
9595/50	2"	1/2"	<b>\$19</b>	<b>\$21</b>	<b>\$19</b>
9595/60	2 3/8"	9/16"	<b>23</b>	<b>28</b>	<b>24</b>

*Suggested retail prices effective January 3, 2023.*

## Door Stops • Solid Brass & Stainless Steel

1147



Proj.	FINISHES			
	US3 US26	US15 US26D	US10B SB	
3"				<b>\$18</b>

1148



Proj.	FINISHES			
	US3 US26	US15 US26D	US10B SB	
3¾"				<b>\$20</b>

2001



**D/O - Discontinued when out of stock.**

Throw	Overall Length	Max. Width	FINISHES	
			US3	
2"	7 1/16"	1 1/8"	<b>\$48</b>	

**Plunger Door Holder**

Operates by stepping on plunger, which is fitted with a white rubber tip. Hold door firmly in any position. Releases by stepping on trigger plate.

7001



Dia.	Ht.	FINISHES			
		US3 US10B US15 US26D	US4 US14 US26 SB	US32D	PVD
7/8"	1 3/16"		<b>\$29</b>	<b>\$19</b>	<b>\$28</b>

7602/35



Dia.	Ht.	FINISH
1"	1 1/16"	<b>US32D \$41</b>

7605/87



Dia.	Proj.	FINISH
1"	3/4"	<b>US32D \$61</b>

7610



Item#	Dia.	Ht.	FINISH
7610/35	1"	1 3/8"	<b>US32D \$21</b>
7610/51	1"	2"	<b>\$33</b>

7000



Item#	Dia.	Ht.	FINISHES			
			US3 US26 US26D	US4 US14 US15 SB	US32D	PVD
7000	1 1/16"	1 11/16"	<b>\$39</b>	<b>\$45</b>	<b>\$29</b>	<b>\$42</b>
7000/55	1 1/16"	2 3/16"	<b>N/A</b>	<b>N/A</b>	<b>39</b>	<b>N/A</b>

7620/35



Sq.	Ht.	FINISH
1"	1 3/8"	<b>US32D \$51</b>

## Ball Catch • Solid Brass

1600F



Faceplate: 2 1/8" L x 1" W  
Strike Plate: 2 1/8" L x 1 3/8" W  
Barrel: 3/4" Dia. x 1 1/4 L

Item#	FINISHES			
	US3 US15	US4 US26	US10B US26D	US14 SB
<b>1600F*</b> Ball Catch	1600F			<b>\$31</b>

\*Ball projection is adjustable.

*Suggested retail prices effective January 3, 2023.*

## Latch & Decorative Hooks • Solid Brass

156



Not Handed

	Height	Lever Width	FINISHES	
			US3	US26
<b>156</b> Shutter Latch / Bi-fold Door Latch	2"	2 <sup>3</sup> / <sub>8</sub> "		<b>\$26</b>

210



	Height	Proj.	FINISHES	
			US3	US26
<b>210</b> Double Hook	3"	3"		<b>\$26</b>

212



	Height	Proj.	FINISHES	
			US3	US26
<b>212</b> Hook	1 <sup>5</sup> / <sub>8</sub> "	1 <sup>5</sup> / <sub>16</sub> "		<b>\$15</b>

213



	Height	Proj.	FINISHES	
			US3	US26
<b>213</b> Double Hook	1 <sup>1</sup> / <sub>2</sub> "	<sup>3</sup> / <sub>4</sub> "		<b>\$15</b>

215



**D/O - Discontinued when out of stock.**

	Base	Proj.	FINISH
			US3
<b>215</b> Triple Swivel Hook	3 <sup>1</sup> / <sub>2</sub> " x 1 <sup>3</sup> / <sub>4</sub> "	4 <sup>5</sup> / <sub>16</sub> "	<b>\$141</b>

*Suggested retail prices effective January 3, 2023.*

## Switchplates • Solid Brass

8004



8004/S SINGLE



8004/D DOUBLE

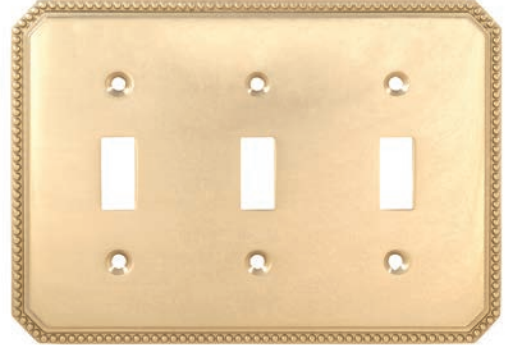

8004/T TRIPLE

**D/O - Discontinued when out of stock.**



8004/R DUPLEX RECEPTACLE



8004/C COMBINATION

Item#	FINISHES		
	US3	US15	US26 SB
<b>8004</b>			
Beaded Design 8004/S	\$29	\$34	\$32
8004/D	42	47	46
8004/T*	52	58	54
8004/R	29	34	32
8004/C	42	47	46

\*Discontinued when out of stock.

8005



8005/S SINGLE

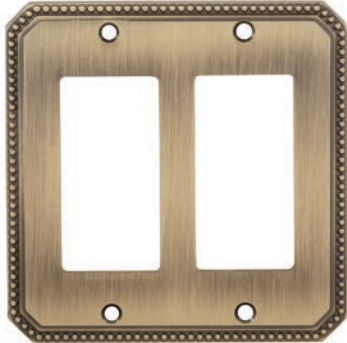

8005/D DOUBLE

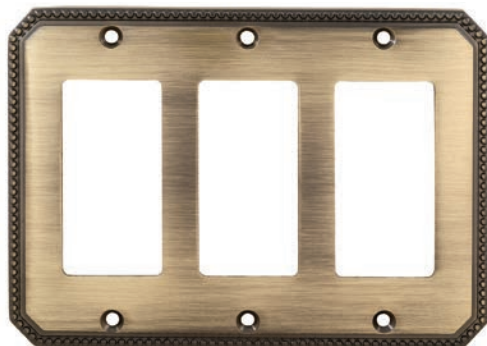

8005/T TRIPLE

**D/O - Discontinued when out of stock.**

Item#	FINISHES		
	US3	US15	US26 SB
<b>8005</b>			
Beaded Design 8005/S	\$29	\$34	\$32
8005/D	42	47	46
8005/T*	52	58	54

\*Discontinued when out of stock.

*Suggested retail prices effective January 3, 2023.*



## Switchplates • Solid Brass

8012



8012/S SINGLE



8012/D DOUBLE



8012/T TRIPLE

D/O - Discontinued when out of stock.



8012/R DUPLEX RECEPTACLE



8012/C COMBINATION

Item#	FINISHES		
	US3	US15	US26 US26D
<b>8012</b>			
8012/S	\$28	\$32	\$29
8012/D	40	46	41
8012/T*	50	55	52
8012/R	28	32	29
8012/C	40	46	41
8012/GFS	41	47	45

\*Discontinued when out of stock.

8023



8023/S SINGLE



8023/D DOUBLE



8023/T TRIPLE

D/O - Discontinued when out of stock.

Item#	FINISHES		
	US3	US15	US26 US26D
<b>8023</b>			
8023/S	\$27	\$32	\$29
8023/D	40	46	41
8023/T*	50	55	52

\*Discontinued when out of stock.

Suggested retail prices effective January 3, 2023.

## Switchplates • Solid Brass

8014



8014/S SINGLE



8014/D DOUBLE



8014/T TRIPLE

D/O - Discontinued when out of stock.



8014/R DUPLEX RECEPTACLE



8014/C COMBINATION

Item#	FINISHES		
	US3	US15	US26 US26D SB
<b>8014</b>			
Traditional Design 8014/S	\$29	\$32	\$31
8014/D	41	47	45
8014/T*	51	57	53
8014/R	29	32	31
8014/C	41	47	45

\*Discontinued when out of stock.

8024



8024/S SINGLE



8024/D DOUBLE

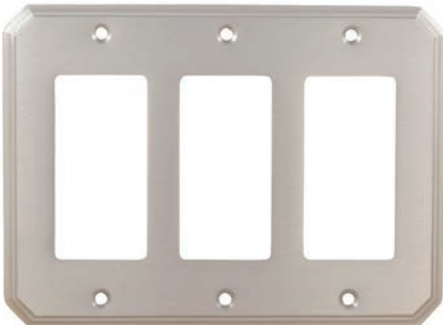

8024/T TRIPLE

D/O - Discontinued when out of stock.

Item#	FINISHES		
	US3	US15	US26 US26D SB
<b>8024</b>			
Traditional Design 8024/S	\$29	\$32	\$31
8024/D	41	47	45
8024/T*	51	57	53

\*Discontinued when out of stock.

Suggested retail prices effective January 3, 2023.

# OMNIA TERMS & CONDITIONS OF SALE

(as of January 3, 2023)

## WARRANTIES

### Limited Mechanical Warranty

OMNIA Industries, Inc. ("OMNIA") offers to the original owner a Limited Warranty that all OMNIA products shall be free of mechanical abnormality for the duration that the original owner inhabits the residence in which the product was originally installed.

#### Exclusions

Any OMNIA product having an abnormality due to improper installation, forced entry, failure to exercise normal maintenance or against the consequences of uses for which our products were not designed is not covered by this warranty. Additionally, if an OMNIA product or component part is used with a product that is not ours or a component part (such as an OMNIA lock or latch with non-OMNIA knobs, levers, escutcheons and roses), any warranty shall be null and void. Warranty does not cover normal wear and tear.

## FINISH WARRANTIES

(Includes General Maintenance)

### Stainless Steel

OMNIA warrants its stainless steel finish shall be free from abnormalities in material and workmanship from tarnishing or rusting for either five (5) years from date of purchase for interior use or one (1) year from the date of purchase on exterior doors only for the duration that the original owner inhabits the residence in which the product was originally installed. Exposure to certain chemical or environmental conditions may promote surface oxidation. Please be aware that this is not an abnormality in the stainless steel but a reaction on the surface of the finish to the chemical environment which can be removed with a stainless steel polish or an abrasive pad. **Surface oxidation is not considered an abnormality in the product.**

### Stainless Steel PVD

The OMNIA PVD finishes use an advanced finishing technology (Physical Vapor Deposition) to create a finish highly resistant to the effects of weather and normal use. For OMNIA products purchased with PVD finishes, OMNIA warrants the finish shall be free from abnormalities in materials and workmanship from tarnishing, flaking or pitting for the **Lifetime** of the applicable product for the duration that the original owner inhabits the residence in which the product was originally installed. Although the OMNIA PVD finishes are highly resistant to the effects of weather and normal use, they do require periodic maintenance. A build-up may occur if it is not performed, which may create a haze or darker look to the finish. This is neither tarnish nor an abnormality in the PVD finish. OMNIA PVD finishes can be maintained simply by wiping with a soft cloth and glass cleaner; or as an alternative, a non-abrasive metal polish which can be purchased at any hardware store. Rubbing alcohol may also be used to clean the surface of PVD finishes. **DO NOT use metal polishes that contain abrasives.**

### Remaining Finishes

OMNIA warrants its finishes (excluding unlacquered finishes, stainless steel and

stainless steel PVD) shall be free from abnormalities in materials and workmanship from tarnishing, flaking or pitting for either five (5) years from date of purchase for interior use, or one (1) year from the date of purchase for use on exterior doors only for the duration that the original owner inhabits the residence in which the product was originally installed. Only use a damp cloth to clean surface of finish to remove dirt and grime. **DO NOT use household cleaners and/or chemicals.**

#### Exclusions

Any OMNIA product having an abnormality due to neglect, misuse, abuse or unreasonable or extraordinary use or lack of normal maintenance is not covered by this warranty. In addition, any OMNIA product having an abnormality due to use of paints, solvents or other chemicals is not covered by this warranty. Discontinued products will not be covered by any warranty. Finishes will not be warranted for any OMNIA product installed on an exterior metal door.

**FOR ALL WARRANTIES, PLEASE NOTE:** OMNIA is not responsible for labor charges related to installation, repair or replacement of any product under this warranty. OMNIA's liability under this warranty shall not exceed the sale price of the product.

## PRICES

Prices are subject to change without notice. Invoices will reflect prices in effect at the time of shipment. OMNIA is not responsible for errors and/or omissions which may appear in any printed material. Orders held by OMNIA because of credit status may be repriced to pricing in effect on date of order release by OMNIA Credit Department.

## RETURNED GOODS

Products must be returned within 60 days of original invoice date. There is a minimum 25% restock fee, plus a freight charge, for all unused and undamaged items returned in original condition. All returns must be accompanied with a completed Return Goods Form (RGF). Any return which exceeds \$1,000 net requires prior authorization. If a factory defect is claimed, please contact OMNIA for replacement or authorization. Any credit due will be determined upon inspection. Reordered or replacement materials will be billed when shipped. Returns will be credited after inspection and approval. All returns must be shipped freight prepaid. COD returns will be refused. Special order or discontinued items will not be accepted for return.

## ORDERS & SPECIFICATIONS

OMNIA has the right to not accept orders in part or whole if the quantity, finishes or prices requested are not suitable. Packing, weights, measurements and designs are subject to change without notice. All special factory orders are non-cancelable, non-returnable and non-refundable.

## ORDER CHANGES

If there are items not readily available, OMNIA will ship and backorder. Items temporarily out of stock will be backordered and so indicated on invoice. Backorders must be canceled prior to shipment of product. Orders canceled after

shipment from OMNIA will incur freight charges and a 25% restocking charge. Address changes after shipment will incur freight charges.

## DISCONTINUED ITEMS & D/O

OMNIA may discontinue product or alter specifications at any time without prior notification or obligation. D/O designates a product which will continue to be available as long as inventory remains, after which the product will be discontinued. This program is intended to help our customers anticipate future needs and to avoid bidding or taking orders on parts which may not be available in sufficient quantities when needed.

## SHIPMENTS

Smaller orders, shipments destined outside the US borders, and **all specially quoted contract orders are shipped FOB Cedar Grove, NJ.** Cremona bolt orders do not qualify for prepaid shipments. Freight charges will apply to contract orders. Please refer to job quote. There will be a handling fee in addition to freight charges. (Drop ship orders incur a higher handling fee.) In certain instances, a fee for insurance coverage may be added. OMNIA will select the quickest and best routes available. Consignee assumes risk of loss or damage after shipments have been delivered to carrier. Claims must be filed with the transportation company. We cannot accept consignee or third party billing for any shipment.

## OPEN ACCOUNTS

Established accounts will be maintained on open account terms as long as payments are kept current. New accounts must submit proper trade and bank references.

## SAMPLE PROGRAM

### Cabinet Hardware

Samples of cabinet pulls up to 6" and cabinet knobs up to 1 1/4" dia. are available free of charge with a \$10 shipping fee for each item ordered. A maximum of 3 samples can be ordered. If ordering more than one sample, the additional samples must all be different part numbers.

### Door Hardware

Single dummy samples of door knobs and levers with a list price value up to \$75 are available free of charge with a \$20 shipping fee for each item ordered. For single dummy samples with a list price value of \$76 and over, there is a \$30 shipping fee for each item ordered.

For each sample ordered, you will receive a discount coupon in the amount of the shipping fee. For each \$100 list purchase made through an authorized OMNIA dealer, you may apply one discount coupon. Since there is no charge for the product samples themselves, they cannot be returned to OMNIA for product credit.

If you are interested in a sample of a product other than cabinet hardware or single dummies, please contact OMNIA for shipping costs.

**An Authorized OMNIA dealer may request a complete Dealer Terms & Conditions by emailing [info@OMNIAindustries.com](mailto:info@OMNIAindustries.com).**



**OMNIA**  
SINCE 1964

5 Cliffside Drive • Box 330  
Cedar Grove, New Jersey 07009  
tel 973.239.7272  
Email: [orders@OMNIAindustries.com](mailto:orders@OMNIAindustries.com)  
[www.OMNIAindustries.com](http://www.OMNIAindustries.com)

